

## INSTRUCTION MANUAL

## G 2 0 SERIES PRESET COUNTER

G 2 0 - 0□□□ 4□□□  
 1□□□ 5□□□  
 2□□□ 6□□□  
 3□□□

\* Before you use G20 series, please read this manual to use this counter correctly.

\* Keep this manual carefully.

\* Contents of this manual are subject to change without notice.

With reading this instruction manual, use correctly before fixing, operating, maintaining and examining.

Keep the following notices not to cause electric shock, injury and damage of device.

### ⚠ WARNING

To prevent from the dangerous condition of user's death or heavy injury, look through the following warning.



◇Supply the voltage between the terminal No. 29 & No. 30 of unit in the range of 85-264VAC. Be sure to confirm the voltage not to cause destruction of the unit by supplying the voltage out of applicable range.



◇Be sure to confirm if there is problem such like looseness of screw, wrong wiring, etc., after wiring.



◇Do not take the unit apart or modify.

## &lt;REQUESTS&gt;

◇Do not use the unit under the following environment.

- Explosive gas, Inflammable gas, Corrosive gas.
- High humidity, Dewdrop.
- Intensive temperature difference
- Intensive vibration.

◇Do not drop or give the high shock to the counter.

◇Be sure to use load current within nominal.

◇Keep away the wiring from the high voltage or current lines.

◇Do not use the blank terminals as relay terminal.

◇Keep the input signal source, counter itself or it's wiring away from the noise source when the counter is used in the noise. It is effective to make the wireleads for input to be shielded.

◇In case there are surge and noise on power supply, connect the line noise filter with counter.

◇In case of wiring for the communication cable outside, equip the baristor to prevent the counter from the lightning shock.

◇Pay attention to the excessive fastening for the screw of terminal and panel clammer.

## FEATURES

- Easy operation by 10 keys
- Power supply, 100-240VAC
- Prescale function
- Tachometer function
- Communication function (RS-485)
- Programmable count start value
- DIN 72 x 144 mm
- Depth, 66 mm. Compact size
- Dust & Splash proof

## MODEL

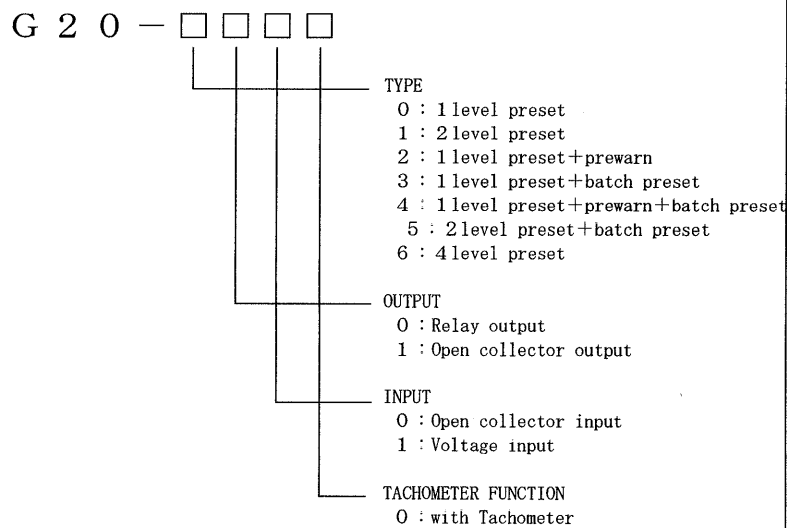

## SPECIFICATIONS

## 1) DISPLAY

Upper display : Red LED 14.22(H) x 7.8(W)  
 Lower display : Green LED 10.00(H) x 5.5(W)

## 2) NUMBER OF DIGITS

Upper display : Preset counter 6 digits  
 Totalizer 6 digits  
 Tachometer 6 digits  
 Batch counter 6 digits  
 Lower display : Preset value 6 digits

## 3) INDICATOR

Yellow LED : It turns on when the display is totalizer & tachometer.  
 Green LED : It turns on when the display shows preset value.  
 Red LED : It turns on when the unit let out the output signal.

## 4) SETTING WAY

10 keys (numerical keys) operation

## 5) SETTING RANGE

Preset value (P1~P4) : -99999~999999  
 Prewarn value (PW) : 0~999999  
 Batch preset value (PB) : 0~999999

## 6) PRESCALE

Multiplying : 0.00001~999.999 Dividing : 1~9999

## 7) DECIMAL POINT POSITION

0.0~0.00000

## 8) COUNT START VALUE

-99999~999999

## 9) INPUT

• Open collector input  
 Sink current : 10 mA L : 0~6V  
 • Voltage input  
 L : 0~4V H : 6~30V (Input impedance 7kΩ)

## 10) COUNT SPEED

30 Hz (Pulse width 16ms Duty 1:1)  
 1 kHz (Pulse width 500μs Duty 1:1)  
 5 kHz (Pulse width 100μs Duty 1:1)  
 8 kHz (Pulse width 62.5μs Duty 1:1)

## 11) TYPE OF INPUT SIGNAL

Add/Subtract/Individual add, subtract/Quadrature

## 12) OPERATION

Overrun/Auto-reset/Equal/Upper-lower limit  
 Model with prewarn function, not include Upper-lower limit  
 Model with batch function, not include Upper-lower limit/Equal

## 13) OUTPUT

One shot pulse/Latch

## 14) OUTPUT TIME

10ms~9990ms (Available to set with 10ms in one unit)

## 15) TYPE OF OUTPUT

• Relay output  
 1c (250VAC 3A/30VDC 3A resistance load)  
 • Open collector output  
 (30VDC 100mA max.)

## 16) OUTPUT DELAY TIME

6ms max.

## 17) RESET

Front reset  
 Remote reset

## 18) KEY LOCK

Prohibition for front key reset, preset value editing, count start value editing or editing data in program mode.

## 19) TACHOMETER

1/TAU, Standard sampling (Measuring accuracy : ±0.1%)  
 What is 1/TAU?  
 The 1/TAU method of rate calculation is based on accurately measuring the time period between consecutive input pulses. This time period is called "TAU".

## 20) COMMUNICATION

RS-485 Serial interface  
 Read count value, preset value or count start value.  
 Send preset value or count start value.  
 Read the condition of reset and preset output condition.

## FRONT PANEL FEATURES

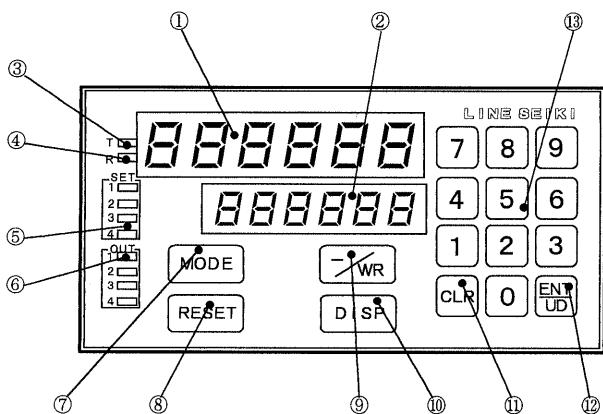

- ① Display for count value, tachometer value, and programming items
- ② Display for preset value and programmed data
- ③ Indicator for total counter
- ④ Indicator for tachometer
- ⑤ Indicator for SET 1 - 1 level preset  
 2 - 2 level preset  
 3 - 3 level preset  
 4 - 4 level preset  
 P - Prewarn  
 B - Batch preset
- ⑥ Indicator for OUT 1 - 1 level preset output  
 2 - 2 level preset output  
 3 - 3 level preset output  
 4 - 4 level preset output  
 P - Prewarn output  
 B - Batch output
- ⑦ Mode key
- ⑧ Reset Key
- ⑨ -/WR key
- ⑩ DISP key
- ⑪ CLR key
- ⑫ ENT/UD key
- ⑬ 10 keys (0-9)

※The design of front membrane is different according to each models.

## ELECTRIC SPECIFICATIONS

- 1) POWER SUPPLY  
 100~240VAC -15%, +10%
- 2) POWER CONSUMPTION  
 approx. 7VA
- 3) SENSOR POWER SOURCE  
 12VDC ±10% 100mA max.
- 4) MEMORY  
 EEPROM (10 years : can be used 100,000 times)
- 5) OPERATING TEMPERATURE  
 -10~50°C (NON FREEZING)
- 6) OPERATING HUMIDITY  
 45~85% RH (NON CONDENSING)
- 7) INSULATION RESISTANCE  
 100MΩ (at 500VDC) minimum
- 8) TEST VOLTAGE  
 1500VAC for one (1) minute
- 9) TEST NOISE  
 Between the terminal on power supply : ±2000V  
 Between the terminal on signal input : ±500V
- 10) TEST OSCILLATION  
 Endurance : 10~55Hz, amplitude 1.5mm, 3 hours(1 cycle 3 minutes) to X,Y,Z 3 directions  
 Operation : 10~55Hz, amplitude 1.5mm, 3 hours(1 cycle 3 minutes) to X,Y,Z 3 directions
- 11) TEST SHOCK  
 Endurance : 300m/s<sup>2</sup> (approx 30G) 10 times to X,Y,Z 3 directions  
 Operation : 100m/s<sup>2</sup> (approx 10G) 10 times to X,Y,Z 3 directions
- 12) SIZE  
 DIN 72 x 144 mm
- 13) WEIGHT  
 approx. 360g

# FRONT PANEL FEATURES

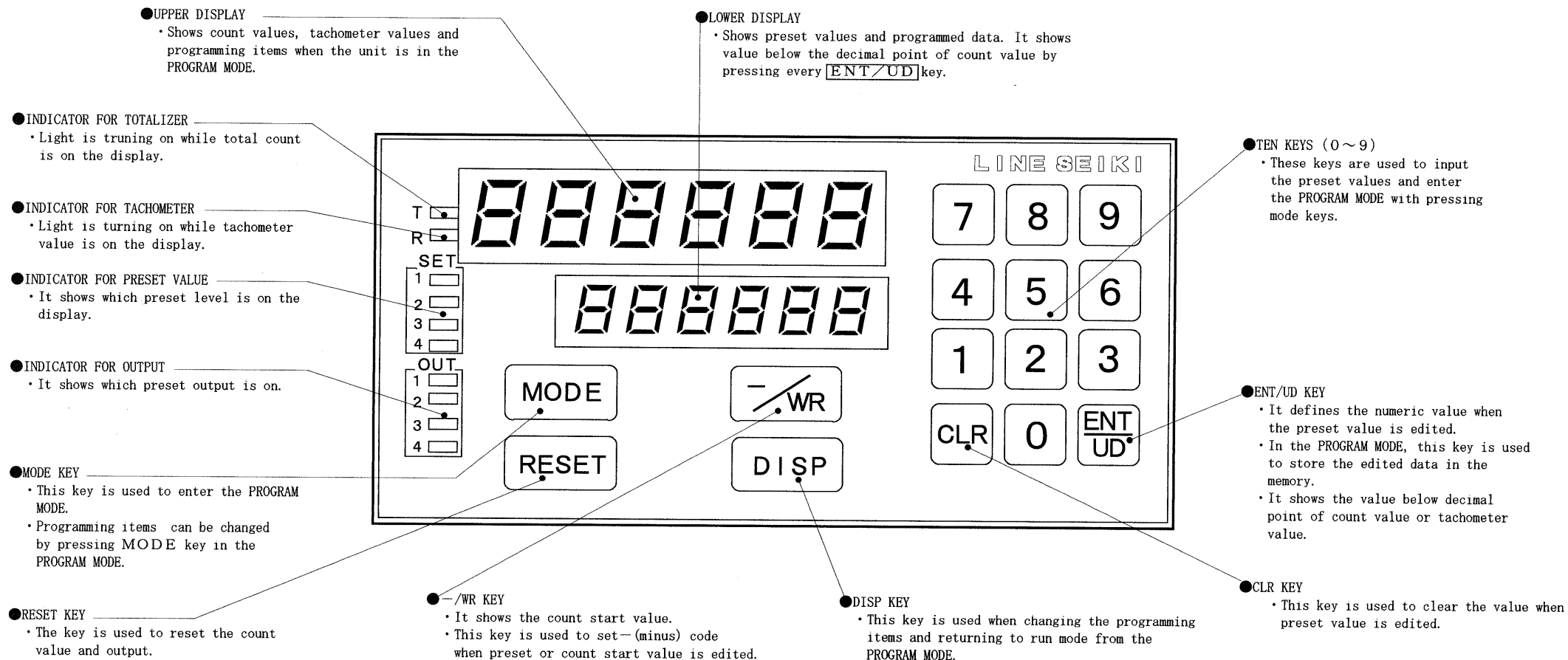

# WIRING AND REAR TERMINALS

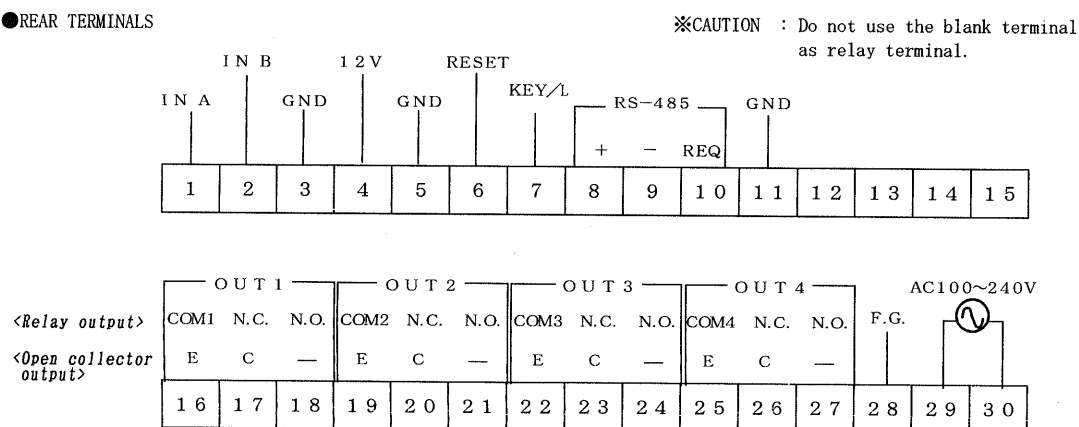

**●LIST FOR OUTPUT TERMINALS**

型式	OUT 1	OUT 2	OUT 3	OUT 4
G 20 - 0□□□	OUT	-	-	-
1□□□	OUT 1	OUT 2	-	-
2□□□	PREWARN	OUT	-	-
3□□□	OUT	BATCH	-	-
4□□□	PREWARN	OUT	BATCH	-
5□□□	OUT 1	OUT 2	BATCH	-
6□□□	OUT 1	OUT 2	OUT 3	OUT 4

(- : NOT AVAILABLE)

# DIMENSIONS AND MOUNTING

**●EXTERNAL DIMENSIONS**

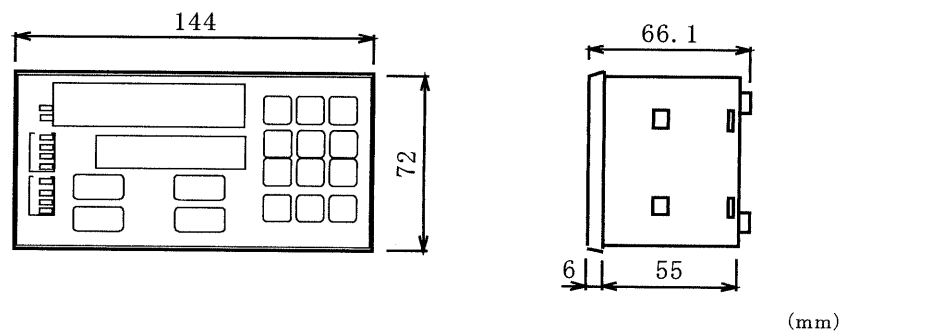

**●MOUNTING**

Insert the unit from front side of panel, and hang the nails of panel clamber on both side or upper-lower side of the unit, and fix the unit by fastening the screw.

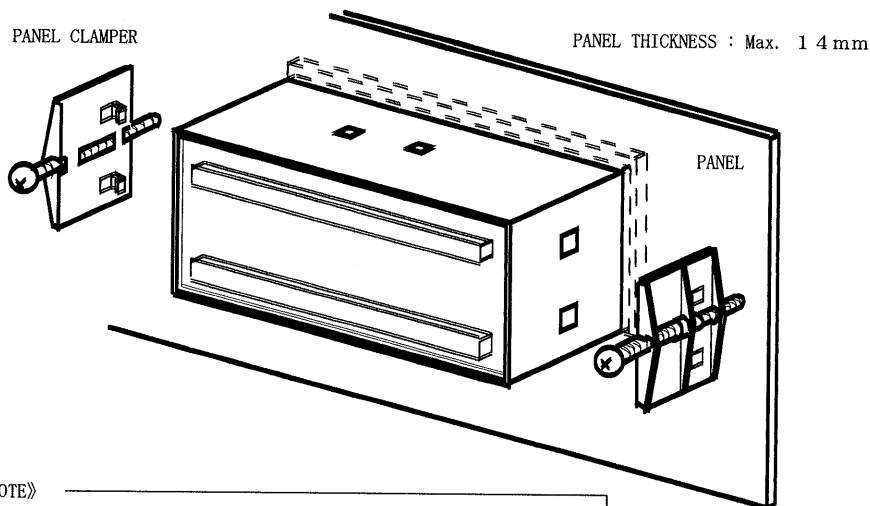

**●NOTE**

- The thickness of panel clamber is approx. 5mm. Make the enough space to arrange other unit on this panel.
- Avoid the excessive fastening for the screw of panel clamber.

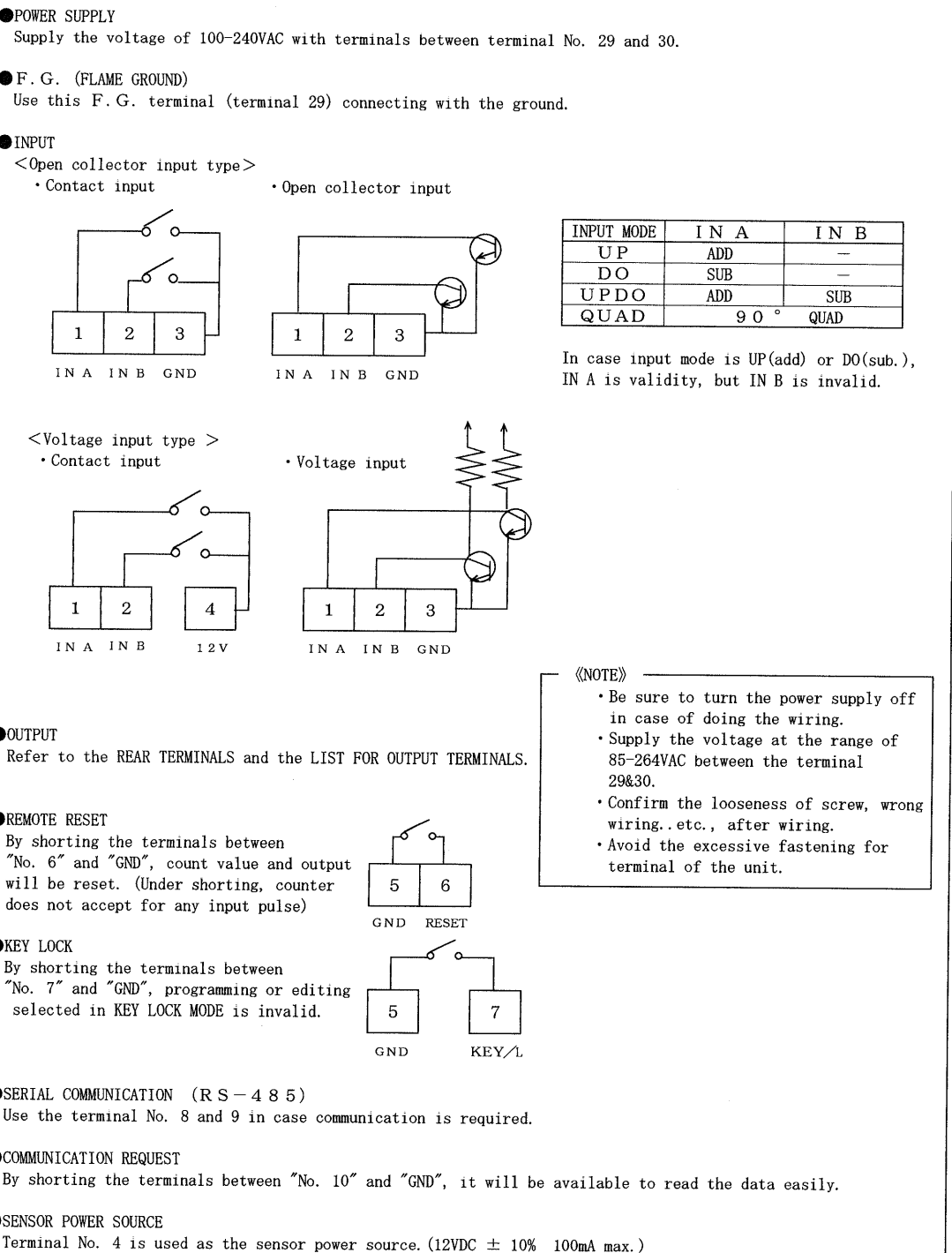

**●NOTE**

- Be sure to turn the power supply off in case of doing the wiring.
- Supply the voltage at the range of 85-264VAC between the terminal 29&30.
- Confirm the looseness of screw, wrong wiring, etc., after wiring.
- Avoid the excessive fastening for terminal of the unit.

# RUN MODE AND PROGRAM MODE OPERATION

Press [MODE] key with 1~4 to enter the program mode.  
Press [DISP] key when returning to run mode.

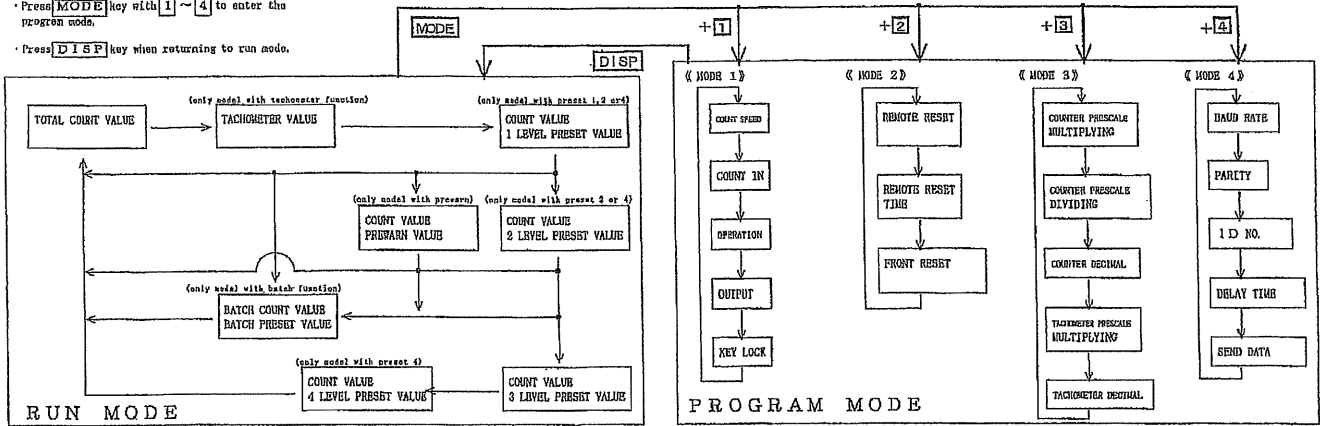

## DETAILS OF PROGRAM MODE

NOTE: Depending on the models, programming items marked with \* do not apply to all models.

(MODE 1)

### ● COUNT SPEED (C.SP) MODE

Count speed can be selected from below.

30 kHz	L	0
1 kHz	H	1
5 kHz	H	5
8 kHz	H	8

### ● COUNT IN (C.I) MODE

Count input method can be selected from below.

ADD INPUT (I/P) → IN A: ADD  
(0 digit) write value → 0 → 9999 → error message (E-Er)

SUBTRACT INPUT (S/P) → IN A: SUB  
(6 digit) write value → 0 → 9999 → error message (U-Er)

ADD/SUBTRACT INPUT (I/P) → IN A: ADD, IN B: SUB  
Error message (U-Er) → 9999 → 0 → 999999 → (I-Er)

QUADRATURE INPUT (Q/I) → Error message (U-Er) → 9999 → 0 → 999999 → (I-Er)

### ● OPERATION (C.OP) MODE \*

Operation method can be selected from below.

OVER RUN	Over
AUTO-RESET	A: rES
EQUAL	E: q
UPPER/LOWER	U: L

UPPER/LOWER limit is not equipped for the model with prewarn.  
EQUAL and UPPER/LOWER limit are not equipped for the model with batch.

### ● OUTPUT (O) MODE \*

When OPERATION MODE is set to OVER RUN or AUTO-RESET, HOLD or ONE SHOT can be selected in OUTPUT MODE. When OPERATION MODE is EQUAL or UPPER/LOWER, HOLD is automatically set. Programming of OUTPUT MODE on each preset level is available.

HOLD	Hold	Hold at the preset value	Overrun Auto-reset
ONE SHOT	OnES	Programming is available at Max. each is 10~9999ms	Overrun Auto-reset

Refer to the following list of output corresponding to each model for the setting.

MODEL	OUT1	OUT2	OUT3	OUT4
G20-0000	OUT	-	-	-
1000	OUT1	OUT2	-	-
2000	PREWARN	OUT	-	-
3000	OUT	BATCH	-	-
4000	PREWARN	OUT	BATCH	-
5000	OUT1	OUT2	BATCH	-
6000	OUT1	OUT2	OUT3	OUT4

### ● KEY LOCK (OPER: KEY OPERATION LOCK) MODE

Key operation to be enabled or disabled can be selected.

OPERATION	OPERATION YES	OPERATION NO
FRONT RESET	rES.y	rES.n
CHANGE ON PRESET VALUE	PrE.y	PrE.n
CHANGE ON CNT. ST. VAL.*	CSE.y	CSE.n
CHANGE ON MODE 1	PG.1.y	PG.1.n
CHANGE ON MODE 2	PG.2.y	PG.2.n
CHANGE ON MODE 3	PG.3.y	PG.3.n
CHANGE ON MODE 4	PG.4.y	PG.4.n

\* CNT. ST. VAL. = COUNT START VALUE

(MODE 2)

### ● REMOTE RESET (E.rES) MODE \*

Remote reset to be enabled or disabled can be selected.

	RESET YES	RESET NO
PRESET COUNTER	rE.y	rE.n
BATCH COUNTER *	bE.y	bE.n
TOTAL COUNTER	tE.y	tE.n

### ● REMOTE RESET TIME (rES.t) MODE

Either can be selected.

1ms	1
20ms	20

This time means minimum pulse time required for remote reset pulse.

(NOTE)

In the case of resetting remotely with contact input (relay, switch and so on), please select 20ms.

### ● FRONT RESET (F.rES) MODE \*

Front reset to be enabled or disabled can be selected.

	RESET YES	RESET NO
PRESET COUNTER	rE.y	rE.n
BATCH COUNTER *	bE.y	bE.n
TOTAL COUNTER	tE.y	tE.n

(MODE 3)

### ● COUNTER PRESCALE (MULTIPLYING) (C.PS) MODE

Counter prescale can be selected from the 3 ranges as below.

0.001 ~ 999.999	Select the range by [ENT/UD] key.
0.001 ~ 99.9999	
0.0001 ~ 9.99999	

### ● COUNTER PRESCALE (DIVIDING) (C.d) MODE

Counter prescale can be set in following range.

1 ~ 9999

### ● COUNTER DECIMAL POINT POSITION (C.dP) MODE

Decimal point position for count values can be selected from below.

0.0000	0.0000
0.000	0.000
0.00	0.00
0.0	0.0
None	

(NOTE)

If decimal point position is changed, the present preset value, count value, etc. are cleared.

### ● TACHOMETER PRESCALE (ONLY MULTIPLYING) (t.PS) MODE \*

Only the model with tachometer is available to be set tachometer prescale as same as counter prescale.

### ● TACHOMETER DECIMAL POINT POSITIONING (t.dP) MODE \*

Decimal point position for tachometer value can be set as same as counter decimal point position.

(MODE 4)

### ● BAUD RATE (bPS) MODE

Transmit speed can be selected from the below.

9600bps	9600
4800bps	4800
2400bps	2400
1200bps	1200
600bps	600
300bps	300

### ● PARITY BIT (P.b) MODE

Parity bit can be selected from the below.

non parity	noP
even no. parity	eP
odd no. parity	oP

### ● I.D NUMBER (I.d) MODE

I.D number can be selected in the range of 00 ~ 99.

### ● DELAY TIME (dEL.t) MODE

Transmit delay time can be set from the below.

2ms	0.002
100ms	0.100

### ● SEND DATA (SEnd) MODE \*

Transmit data can be programmed on the following items.

	SEND	NOT SEND
PRESET COUNT VALUE	rE.y	rE.n
BATCH COUNT VALUE *	bE.y	bE.n
TOTAL COUNT VALUE	tE.y	tE.n
1 LEVEL PRESET VALUE	P1.y	P1.n
2 LEVEL PRESET VALUE *	P2.y	P2.n
3 LEVEL PRESET VALUE *	P3.y	P3.n
4 LEVEL PRESET VALUE *	P4.y	P4.n
PREWARN VALUE *	Pw.y	Pw.n
BATCH PRESET VALUE *	bP.y	bP.n

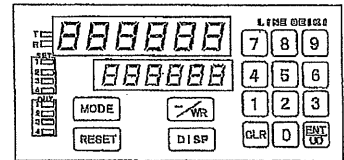

## HOW TO PROGRAM PRESET VALUE

The preset value can be programmed in the RUN MODE.

EXAMPLE: Change of the preset value from 100 to 2500.

- 1) Press [DISP] key to display preset value. (SST 1 indicator lights)



- 2) Press [CLR] key. The number 0 on the lower display will blink.



- 3) Set the preset value by using 0-9 numerical keys.

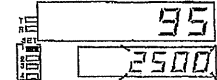

\* For minus value input, press [WR] key first.  
\* Press [CLR] key to cancel the set value. In this case, the lower display shows previous preset value.

- 4) Press [ENT/UD] key to determine the preset value. (Blinking stops and the setting is completed)

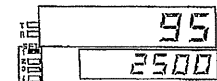

How to set or change the preset value is all the same in any models.

## HOW TO PROGRAM COUNT START VALUE

The count start value can be programmed in the RUN MODE.

- 1) Make preset count value show.

- 2) Press [WR] key to display count start value. (C.SST is indicated on the lower display. The count start value is displayed on the upper display)

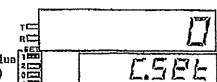

- 3) Press [CLR] key. 0 will blink.

- 4) Set the count start value by using numerical keys.

\* Press [WR] key first when the setting value is minus.  
\* Press [CLR] key to clear the set value. In this case, the lower display shows the previous value.

- 5) Press [ENT/UD] key to determine the count start value. (Blinking stops, and setting is completed)

- 6) Press [WR] key to make the display shows the preset count value.

- 7) By front key reset or remote reset on, the count start value can be shown on the upper display.

## BATCH FUNCTION

MODEL G20-3000, 4000, 6000 have batch function.

G20-3000, 4000: One count is added when the counts reached to the 1 level preset value.

G20-5000: One count is added when the counts reached to the 2 level preset value.

# OPERATION OF PROGRAM MODE

NOTE: Depending on the models, program items marked \* do not apply to all models.  
See the programming details of program mode and list of output.

## MODE + 1

PROGRAM ITEM	UPPER DISPLAY	LOWER DISPLAY (PROGRAMMING DETAILS)	OPERATION
COUNT SPEED	C.SPd	Lo. 30 → Hi. 1 → Hi. 5 → Hi. 8	[ENT/UD] key to change the programming details.
COUNT IN	C.i.n	UP → do → UPdo → qudd	[ENT/UD] key to change the programming details.
OPERATION	C.Act	0.run → A.rP5 → EQu. → UL.LL	[ENT/UD] key to change the programming details.
OUTPUT	Out 1 ~ Out 4	<p>◆ When 0.run or A.rP5 selected Hold → OnP.5 (Set one shot output pulse time for 10~9990 (msec) when OnP.5 is selected.)</p> <p>◆ When UL.LL selected UL → LL</p>	[ENT/UD] key to change the programming details. (program on each level) Set one shot time by numerical keys.
KEY LOCK	OPER	rP5.y → rP5.n (Reset key) PrP.y → PrP.n (Preset value change) C.SE.y → C.SE.n (Count start value change) PG1.y → PG1.n (PROGRAM MODE 1 change) PG2.y → PG2.n (PROGRAM MODE 2 change) PG3.y → PG3.n (PROGRAM MODE 3 change) PG4.y → PG4.n (PROGRAM MODE 4 change)	[ENT/UD] key to select (UL) or (LL).  [ENT/UD] key to select yes(y) or no(n).

## MODE + 2

PROGRAM ITEM	UPPER DISPLAY	LOWER DISPLAY (PROGRAMMING DETAILS)	OPERATION
REMOTE RESET	E.rP5	PC y → PC n (Preset counter) bC y → bC n (Batch counter) tC y → tC n (Total counter)	[ENT/UD] key to select yes(y) or no(n).
REMOTE RESET TIME	rP5.t	1 → 20	[ENT/UD] key to change the programming details.
FRONT RESET	F.rP5	PC y → PC n (Preset counter) bC y → bC n (Batch counter) tC y → tC n (Total counter)	[ENT/UD] key to select yes(y) or no(n).

## MODE + 3

PROGRAM ITEM	UPPER DISPLAY	LOWER DISPLAY (PROGRAMMING DETAILS)	OPERATION
COUNTER PRESCALE (MULTIPLYING)	C.P5	0.001 ~ 999.999 ↓ 0.0001 ~ 99.9999 ↓ 0.00001 ~ 9.99999	[ENT/UD] key to change decimal point position. Enter prescale value by numerical keys.
COUNTER PRESCALE (DIVIDING)	C.d.i.u	1 ~ 9999	Enter prescale value by numerical keys.
COUNTER DECIMAL POINT	C.dP	0 → 0.0 → 0.00 → 0.000 ← 0.00000 ← 0.0000 ←	[ENT/UD] key to change programming details.
TACHO. PRESCALE (MULTIPLYING)	t.P5	0.001 ~ 999.999 ↓ 0.0001 ~ 99.9999 ↓ 0.00001 ~ 9.99999	[ENT/UD] key to change decimal point position. Enter prescale value by numerical keys.
TACHOMETER DECIMAL POINT	t.dP	0 → 0.0 → 0.00 → 0.000 ← 0.00000 ← 0.0000 ←	[ENT/UD] key to change programming details.

## MODE + 4

PROGRAM ITEM	UPPER DISPLAY	LOWER DISPLAY (PROGRAMMING DENIALS)	OPERATION
BAUD RATE	bP5	9600 → 4800 → 2400 ← 300 ← 600 ← 1200	[ENT/UD] key to change the programming details.
PARITY BIT	P.b.i.t	None → Even → Odd	[ENT/UD] key to change the programming details.
ID NO.	i.d	00 ~ 99	Enter ID No. by numerical keys.
DELAY TIME	dEL.t	0.002 → 0.100	[ENT/UD] key to change the programming details.
SEND DATA	Send	PC y → PC n (Preset count value) bC y → bC n (Batch count value) tC y → tC n (Total count value) P1 y → P1 n (1 level preset value) P2 y → P2 n (2 level preset value) P3 y → P3 n (3 level preset value) P4 y → P4 n (4 level preset value) Pn y → Pn n (Prewarn value) bP y → bP n (Batch preset value)	[ENT/UD] key to select yes(y) or no(n).

# COUNT AND OUTPUT (1)

● G20-0□□□, 1□□□, 3□□□, 5□□□, 6□□□ (MODEL FOR 1 LEVEL, 2 LEVEL, 4 LEVEL or WITHOUT PREWARN)

### OVER RUN

OUT1: ONE SHOT or HOLD  
OUT2: HOLD

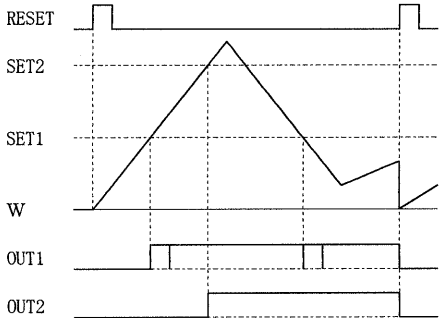

OUT1: ONE SHOT or HOLD  
OUT2: ONE SHOT

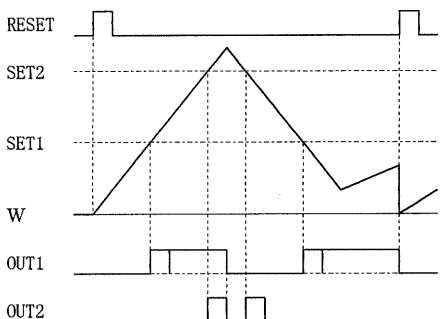

### AUTO-RESET

OUT1: ONE SHOT or HOLD  
OUT2: HOLD

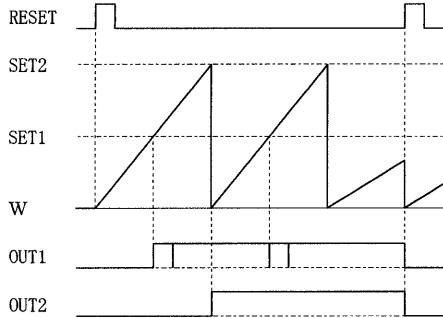

OUT1: ONE SHOT or HOLD  
OUT2: ONE SHOT

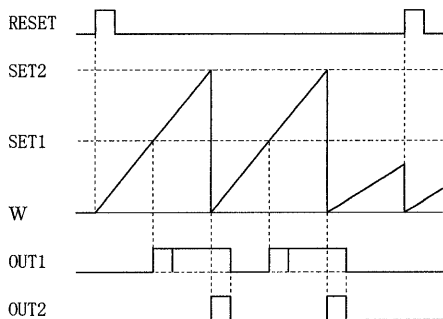

### EQUAL

Output is ON while the count value is equal to the counter preset value.

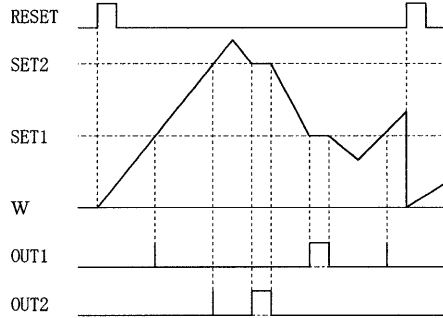

### UPPER/LOWER LIMIT

OUT1: LL (LOWER LIMIT)  
OUT2: UL (UPPER LIMIT)

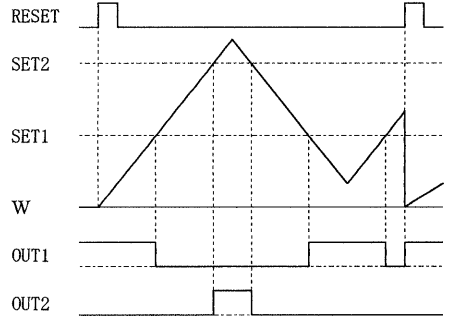

• Output of each preset levels is individual each other. Refer the above drawings.  
EQUAL and UPPER/LOWER limit are not selectable on the model with Batch function.

### BATCH FUNCTION

G20-3□□□, 5□□□ have Batch function.  
Batch counter counts 1 when the count value reaches to the preset value of the last level.

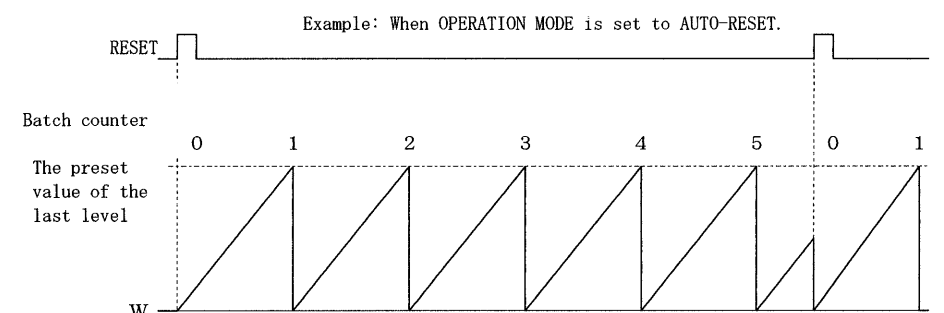

• For 2 level or 4 level preset type, when output of the last preset level is set at ONE SHOT, all outputs are turned to OFF by the falling edge of ONE SHOT pulse.

## COUNT AND OUTPUT (2)

● G20-2□□□, 4□□□ (1 level with prewarn)

Model with prewarn has no UPPER/LOWER output in the OPERATION MODE. For G20-4□□□, the model with batch function, EQUAL output is not available and only OVERRUN or AUTO-RESET is available in OPERATION MODE. OUT1 is prewarn output, OUT2 is preset output. On the model with batch function, OUT3 is batch output.

### • OVER RUN

OUT1 (Prewarn output) : ONE SHOT or HOLD  
OUT2 (Preset output) : HOLD

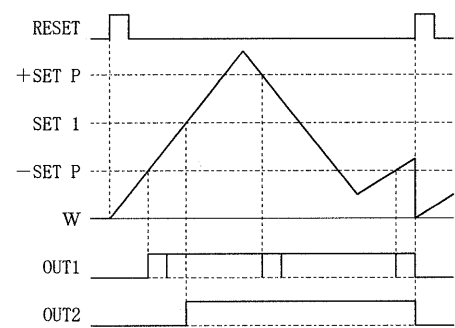

OUT1 (Prewarn output) : ONE SHOT or HOLD  
OUT2 (Preset output) : ONE SHOT

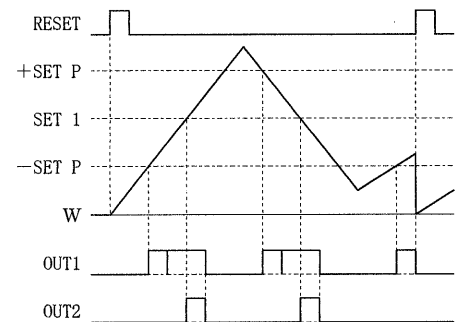

- When OUT2 (Preset output) is set to ONE SHOT, OUT1 (Prewarn Output) turns to be OFF by the falling edge of that ONE SHOT pulse.
- Prewarn output is ON only when the count value is near to SET 1 (1 level preset value).

### • AUTO RESET

OUT1 (PREWARN OUTPUT) : ONE SHOT or HOLD  
OUT2 (PRESET OUTPUT) : HOLD

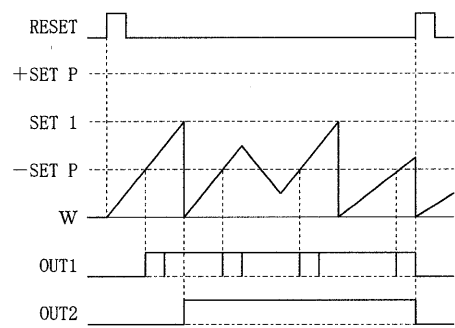

OUT1 (PREWARN OUTPUT) : ONE SHOT or HOLD  
OUT2 (PRESET OUTPUT) : ONE SHOT

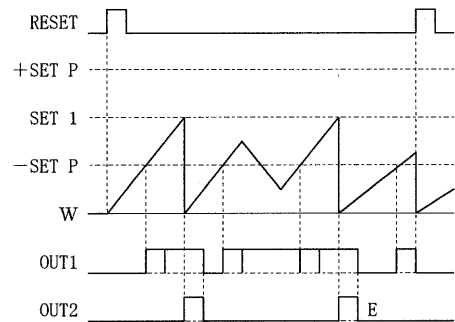

• EQUAL (Only for the model without batch function)  
OUT1 (Prewarn output) is ON only when the count value is near to SET 1 (1 level preset value).  
OUT2 (Preset output) is ON only when the count value is equal to SET 1.

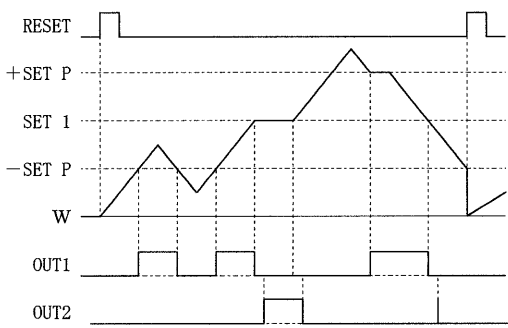

## RESET

● Type of reset :

- Front reset
- Remote reset \*
- Reset by serial communication command

\* Does not count during shorting.

● Subject to be reset:

- Count value (Preset count value) and output
- Total count value
- Batch count value
- Error (Overflow, Underflow)

Reset able or disable are can be selected in the PROGRAM MODE.

Reset of count value (Preset count value) enables all preset outputs to be OFF.

● The determined count start value can be shown on the upper display by reset ON. The count start value at ex-fact is set to 0.

### ● BATCH OUTPUT

G20-4□□□ has Batch function.

Batch counter counts 1 when the preset counter reaches 1 level preset value. The batch output turns ON when the batch count reaches the batch preset value. For the batch output, ONE SHOT or HOLD can be selected.

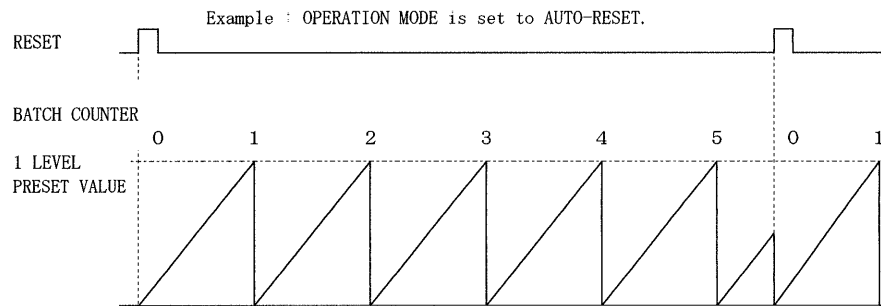

## SERIAL COMMUNICATION (1)

● The control uses ASCII code with the RS-485 serial specification.

● This allows bi-directional communications and addressing of multiple controls on a single two-wire communication bus.

● Each unit is individually addressed via a user programmable ID number. Up to 32 G20 counters can be connected directly to the bus.

### ※ SERIAL COMMAND SUMMARY

RDD : Read count value/preset value. (display only)  
RDI : " (value of integral number)  
RDU : " (value of under decimal point)  
WRD : Write preset value.  
RES : Reset for count value and condition of over/under flow error.  
RDO : Read output condition.  
STP : Count prohibition.  
RSM : Cancellation for count prohibition.  
LTD : Store count value/preset value in memory of counter.  
RLD : Read stored data by LTD command.

#### 《NOTE》

- It can not be to communicate if the count input pulse speed goes over the max. count speed.
- Use only the character of capital letter in communication.

### ◆ TRANSMISSION FORMAT

The general command is shown below. Spaces are used for clarify only and must not be transmitted.

> ID# COMMAND (numerical data) CHECKSUM (c r)

Example: To cause the unit #10 to transmit the value of main counter, send the RDD command as follows.

>	10	RDD	PC	CE	(c r)
①	②	③	④	⑤	⑥

- ① Message start character (ASCII 62). Required for all transmission to the control.
- ② Two digits serial port ID# in decimal. Required for all transmission to the control. Unit ID#10 (decimal) is unit ID#0A (hexadecimal), capital letters must be used.
- ③ RDD command. All serial commands consist of three characters.
- ④ Sub command decides the details for serial command. This command means the read of preset count value by PC.
- ⑤ Checksum.

#### CHECK SUM CALCULATION

1	0	R	D	D	P	C
---	---	---	---	---	---	---

$$49 + 48 + 82 + 68 + 68 + 80 + 67 = 462 \text{ (Dec.)}$$

$$= 1CE \text{ (Hex.)}$$

Check sum is the last two hexadecimal charring.  
The > start character and carriage return (c r) are not used in calculation.

- ⑥ ASCII carriage return (13 decimal). Required at the end of all commands.

### ◆ RESPONSE FORMAT

#### RESPONSE RECOGNITION FORMAT

The counter does not respond to a command unless the transmitted ID number matches its programmed ID number.

If the ID numbers match and the command and checksum are valid, the control executes the command and transmits a response as shown below.

[A] [DATA] [CHECK SUM] (c r)

[A] is the acknowledge character sent when any valid command is received and executed.

[DATA] is sent in response to request data.

[CHECK SUM] is sent only when data is requested (RDD, RDI or RDU commands).

The checksum is calculated by adding the ASCII values of all preceding characters (including the "A" and spaces). The checksum is the two least significant digits of this sum in hexadecimal.

(c r) is the ASCII carriage return (13 decimal). Transmitted at the end of all responses

Ex 1 : A (c r) = No data requested.

Ex 2 : APC 123456 48 (c r) = Count data requested.

#### ERROR RESPONSE FORMAT

If the ID numbers match but the command is not valid or cannot be executed, the counter ignores the command and responds by sending an ASCII "N" (not acknowledged), followed by one character and carriage return.

#### ※ ERROR CODES

- N02 : CHECKSUM ERROR  
Received checksum does not match the calculated check sum.
- N05 : INVALID DATA  
Incorrect number of digit or illegal characters received in data field.
- N11 : RESET EDIT IN PROGRESS ON KEY BOARD  
Serial preset cannot be sent if the preset is being changed on the key board.
- N13 : KEY BOARD PROGRAM MODE IS ACTIVE  
Cannot enter serial the PROGRAM MODE if in the key board PROGRAM MODE.
- NFF : UNDER OVERFLOW or UNDERFLOW FOR COUNT VALUE  
It is impossible to communicate under displaying for overflow error or underflow error. It is possible to communicate by reset command for error cancellation as the exception.

EX1 : N05 (c r) = Invalid data

### ◆ RS-485 SERIAL INTERFACE

WAY OF COMMUNICATION Half duplex, Asynchronous

FORMAT ASCII code  
Start bit 1 bit  
Data bit 8 bit (including parity bit)  
Stop bit 1 bit  
Parity bit 1 bit

BAUD RATE 300/600/1200/2400/4800/9600 bps (Selection)

PARITY NON/ODD/EVEN (Selection)

## SERIAL COMMUNICATION (2)

### ◆ EXPLANATION FOR COMMUNICATION COMMAND

1. **RDD (XX)** : Read Count value / Preset value

- This requires sub command with two(2) figures(XX). In accordance with required data, sub command is decided.
- The response are shown as [sub command] [data] [check sum] [cr] in order.
- The decimal point positioning is also shown the same as the display of counter in this response.
- The zero [0] in needless is read as a space.

Example for read : >01RDDPCCB(cr) = Read preset count value in unit No. 01.

Example for answer: APC -123.45 4D(cr) = preset count value -123.45.

Communication sub command. (XX)	Contents of command
PC	Preset count value
BC	Batch count value
TC	Total count value
TM	Tachometer value
P1	1 level preset value
P2	2 level preset value
P3	3 level preset value
P4	4 level preset value
PW	Prewarn value
BP	Batch preset value
SO	Items selected for SEND DATA in the PROGRAM MODE

※ Communication sub command is different according to each models

2. **RDI (XX)** : Read Count value/Tachometer value(the value of integral)

3. **RDU (XX)** : Read Count value/Tachometer value(the value of under decimal point)

- This command works the same as RDD command. Only 3 kind of sub command as shown below are available.
- RDI is the command to read the value of integral part in count value or tachometer value.
- RDU is the command to read the value under the decimal point in count value or tachometer value.

Example for send : >10RDUFCBP(cr) = Read the preset count value in unit No. 10.

Example for response: APC. 12000000 64(cr) = Preset count value (under the decimal point): 12.

Communication sub command. (XX)	Contents of command
PC	Preset count value
TC	Total count value
TM	Tachometer value

4. **WRD (XX)** : Set the preset value.

- This requires sub command with 2(two) figures (XX). In accordance with the contents of command, sub command is decided as shown below.
- The response is [A] (cr) only.
- The decimal point position can not be set by WRD command. The decimal point is shown at the position set in the program mode.

Example for send : >10WRDP1001234F9(cr) = set 1 level preset value in the unit No. (ID No.)10.

Communication sub command. (XX)	Contents of command
P1	1 level preset value
P2	2 level preset value
P3	3 level preset value
P4	4 level preset value
PW	Prewarn value
BP	Batch preset value

※ Communication sub command is different according to each models.

5. **RES (XX)** : Reset

- This requires sub command with two(2) figures (XX). In accordance with the contents of command the sub command is decided as shown below.
- The response is [A] (cr) only.
- This command works same as front reset key operation or reset input.

Example for send:>00RESPCDD(cr) = Reset preset count value in unit No. (ID No.)00.

Communication sub command. (XX)	Contents of command
PC	Preset count value
BC	Batch preset value
TC	Total count value
ER	Cancelling for error condition (over, under flow)

※ Communication sub command is different according to each models.

6. **RDO** : Read output condition (respective condition in out 1 - out 4)

- The response is shown [A] [OUT 1 (Hex)] - [OUT 4 (Hex)] [Check sum] (cr) in order.

Example for send: >00RDO46(cr) = Read output condition in unit No. 00.

Example for response: A1L2H3L4L76(cr) = The output condition are as shown below in this example for response.

※OUT1~OUT4 is different according to each models.

1L	OUT1 → Low
2H	OUT2 → Hi
3L	OUT3 → Low
4L	OUT4 → Low

7. **STP** : Count prohibition

8. **RSM** : Cancellation for count prohibition

- When STP command is sent to the counter, counter does not enter any count input pulse until the counter received RSM command.
- Count prohibition will be cancelled when the power supply of counter is cut off. When the power supply of counter turns on, counter begins to accept the input pulse.
- The response is [A] (cr) only.

Example for send: >00STP57(cr) = Count prohibition in unit No. 00.

>00RSM52(cr) = Cancellation for count prohibition in unit No. 00.

9. **LTD (XX)** : Store count value, tachometer value or preset value in the memory

- This requires sub command with two(2) figures. In accordance with the contents of command, sub command is decided as shown below.
- The data which can be memorized by this command is only one (1) item per once. In case this command is carried out newly, new data will be memorized instead of previous data.
- The response is [A] (cr) only.
- When the power supply of counter is cut off, the memorized data will be deleted.

Example for send: >00LTDPCD7(cr) = Store preset count value of unit No. 00 in its memory

Communication sub command (XX)	Contents of command
PC	Preset count value
BC	Batch count value
TC	Total count value
TM	Tachometer value
P1	1 level preset value
P2	2 level preset value
P3	3 level preset value
P4	4 level preset value
PW	Prewarn value
BP	Batch preset value

※ Communication command is different according to each models.

10. **RLD** : Read the data stored by LTD command

- The response is shown as [sub command][data][check sum][cr] in order.
- In this response, the decimal point position showed on the display is also sent.
- The zero [0] in needless are sent as a space.
- If the RLD command is carried out before the data is stored by LTD command, the response will be error code.

Example for send: >00RLD42(cr) = Read the stored data of unit No(ID No.) 00 in its memory.

Example for response: APC -123.45 4D(cr) = Preset count value -123.45.

### ◆ EASY COMMUNICATION (COMMUNICATION REQUEST)

- Easy communication (Communication request)

For the way of easy communication, there is the function named communication request in this counter. By shorting the terminal of "communication request" and "GND", it reads the data set for SEND DATA in the program mode.

Example for set : When the data of the preset count value and 1 level preset value are set for SEND DATA in the PROGRAM MODE.

Example for response: APC 123.00 P1 200.00 59(cr)  
The above example shows : Preset count value is 123.00  
1 level preset value is 200.00

This manual was last revised July. 5, 2011. 4G20002C

\*Subject to change without prior notice.

All Rights Reserved, Copyright © 2011, LINE SEIKI CO., LTD.



LINE SEIKI CO., LTD.

NO.37-7, Chuo-cho 2-Chome, Meguro-Ku, Tokyo, 152 Japan

TEL. +81-3-3716-5151 FAX. +81-3-3710-4552