

DK-5000 SERIES MANUAL

INSTRUCTION MANUAL

DK-5010B

TYPE

B

Thank you for purchasing our product, DK-5010B.
Please confirm that you have the correct device by checking the product label.
Please read this instruction manual carefully before using this device to ensure correct usage.
Please keep this instruction manual for future reference.

INTRODUCTION

DK-5010B is an input device which logs timestamp of ten (10) input keys. It can save records in its memory and has a built-in calendar clock for timestamp. Its ten input keys can be used to monitor different types of event, attribute or classification.

※ Important!
This device requires DK-5000 Mieruzzo Software to view record details. The software runs on Windows 7, 8, 8.1 or 10 OS.
Please use a micro B-to-A USB cable to connect the DK-5010B device to a computer.

The companion software enables user to download, delete and save data from the device to a computer. The software also enables real-time display of the device on a computer.

POWER SUPPLY

The device can be powered through three power supply options. The list below shows the power supply options according to priority of usage:

- ▶ 5.5mm DC Jack @9V, 50mA ※
- ▶ USB Power @5V, 100mA
- ▶ 4pcs. AAA Battery

※ Please use Line Seiki AC/DC Power Adapter for DK-5000 (sold separately) to power the device via DC Jack.

Upon initial connection to a power supply or resumption of power, the device will perform the start-up routine, blinking all LCD segments for 2 – 7 seconds. After the start-up routine, the device will proceed to Date & Time Setting Mode to set the device Date & Time.
(See KEY OPERATION for details.)

※ Important!
Calendar clock will not update when there is no power supply available. Make sure that there are batteries installed before disconnecting both DC jack and USB power supply to maintain calendar clock function. When DC jack or USB power is connected, power is not supplied from the batteries and battery charge will not be drained.

When operating only on batteries, fresh Alkaline type batteries can provide at least up to 200 hours of operation, under normal operating condition.

☹ icon will appear on the upper right corner of the display to indicate a low battery condition.
☹ icon will blink continuously under following conditions:

- ▶ when battery is almost empty
- ▶ when no battery is installed while the device is powered by DC jack and/or USB

If all power supplies are removed, the last device Date & Time will be stored in a temporary memory. If device is in Recording Mode, Record will be saved. When the device is powered ON again, it will resume operation in Date & Time Setting Mode using the last saved Date & Time values.
(See KEY OPERATION for details.)

OPERATION MODES

This device has four main operation modes, namely:

- 1 Standby Mode 2 Recording Mode 3 Setting Mode 4 Memory Recall Mode

Standby Mode

This is the default operation mode. Standby Mode is indicated by the displayed text "Standby". The TIME icon and the current time is also shown on the upper left side of the display.

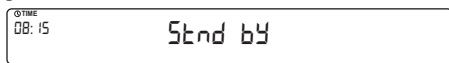

Logging of input key press is disabled in this mode.

By pressing the corresponding key combination of [F] with [1], [2] or [3], other operation modes can be accessed from Standby Mode. By holding down [#], Recording Mode can be enabled.
(See KEY OPERATION for details.)

Recording Mode

Recording Mode is indicated by the displayed number of inputs for each input key and the total inputs. The TIME icon and the current time is also shown on the upper left side of the display.

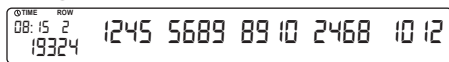

Logging of input key press is enabled in this mode. The number of inputs for each input key and the total inputs are updated with every press of corresponding input key.

By pressing the corresponding key combination of [F] with [1], [2] or [3], other operation modes can be accessed from Recording Mode. By holding down [#], Standby Mode can be enabled.
(See KEY OPERATION for details.)

Setting Mode

There are two Setting Modes:

- a.) Date & Time Setting
- b.) Device ID Setting

When accessed from Standby Mode, Date & Time, and Device ID can be viewed and edited, respectively. When accessed from Recording Mode, editing is disabled.
(See KEY OPERATION for details.)

Memory Recall Mode

This mode enables viewing of all saved Records on the device memory. Memory Recall Mode is indicated by MEM icon and the 4-digit Memory No. shown on the upper left side of the display.



Memory No. represents the memory location of the Record displayed. When a Record is deleted, the memory location of each Record shifts and Memory No. is changed accordingly.



Please note that misuse of this device may lead to injury to the user or damage to the device. Please observe all safety precautions and warnings in this instruction manual.

Customer Service



LINE SEIKI CO., LTD.

Head Office 37-7 Chuo-cho, 2-Chome Meguro-ku,
Tokyo JAPAN 152-0001
Contact TEL : 03-3716-5151 FAX : 03-3710-4552
E-mail webtrade@line.co.jp
URL http://www.lineseiki.com

There are two display modes available for viewing stored Records:

- a.) Timestamp Display
- b.) Input Value Display

Timestamp Display mode will show the date and time when the Record is saved.

Input Value Display mode will show the number of individual inputs and the total inputs.

Memory Recall Mode also provides an option to clear all Records saved in the device memory.
(See KEY OPERATION for details.)

SOFTWARE

This device works with DK-5000 Mieruzzo Software. The software is downloadable for free from the Line Seiki website.

The software enables the user with the following functions:

- download the data from the device
- export the downloaded data to a .XLS or .CSV file
- delete records stored in the device
- sync device time to computer system time
- change Device ID

The software also has an Auto Acquire function which enables real-time display of the number of inputs displayed on the device. The display is updated every 1 second.

Please refer to the DK-5000 Mieruzzo Software User Manual for more details.

When the device is connected to the software, the icon will appear on the upper right corner of its display.

LABELS

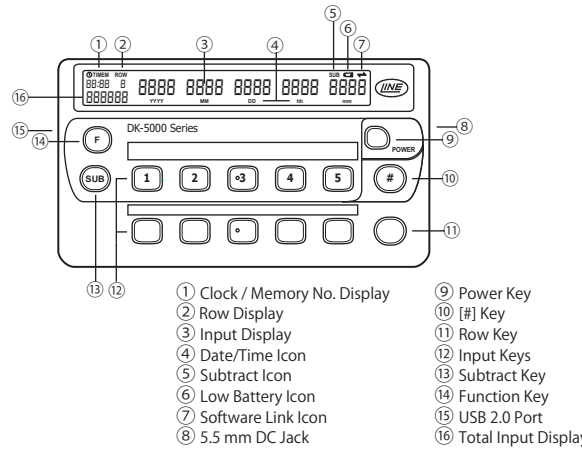

KEY OPERATION

POWER KEY

Power (On/Off)

- ◆ To switch ON, hold down [POWER] for 1 second.
The default power up display is Standby Mode showing the text "Standby" on the display.
- ◆ To switch OFF, hold down [POWER] for 3 seconds.
When switching off from Recording Mode, the Record will be ended and saved before switching off.

[F] KEY

Date & Time Setting

- ◆ Hold down [F] and press [1] to enter the Date & Time Setting Mode. The display will show the Date and Time value in the format below:
"YYYY-MM-DD-hh-mm".



The Year, Month, Day, Hour or Minute values can be incremented by pressing [1], [2], [3], [4] or [5]. Holding down [1], [2], [3], [4], or [5] will continuously increment these values, respectively.

- ◆ Press [F] to leave the Date & Time Setting Mode.

Note:

- * Editing of Date & Time is disabled when accessed from Recording Mode.

Device ID Setting

- ◆ Hold down [F] and press [2] to enter the Device ID Setting Mode. The display will show the Device ID, a 3-digit user-programmable number which is used to identify different DK-5000 devices.



[F] KEY



Device ID Setting (continuation)

- Each digit of the Device ID can be incremented by pressing [3], [4] or [5]. Holding down [3], [4] or [5] will continuously increment each digit.
 - ◆ Press [F] to leave the Device ID Setting Mode.
- Note:
* Editing of Device ID is disabled when accessed from Recording Mode or when there is an active connection to the companion software.

Memory Recall

- ◆ Hold down [F] and press [3] to enter Memory Recall Mode. The display will show the Memory No. and Timestamp of the newest Record saved.



If there is no Record available, the display will show "no data".



- ◆ Press [1] to display the next Record.
- ◆ Press [2] to display the previous Record.
- ◆ Press [3] to toggle Timestamp Display mode.
- ◆ Press [4] to toggle Input Value Display mode.
- ◆ Press [5] to enter Memory All Clear Mode.
- ◆ Press [F] to leave the Memory Recall Mode.



Memory All Clear

- ◆ When in Memory All Clear Mode, the display will show the "All Clear" options.



- ◆ Hold down [4] for 1 second to select "Yes". All Records will be deleted and device will return to Memory Recall Mode, "no data" will be displayed. While clearing the memory, device will show "All Data to Clear".

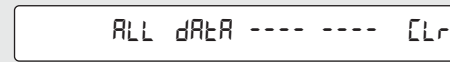

- ◆ Press [5] to select "No". No Record will be deleted and the device will return to Memory Recall Mode.
- ◆ Press [F] to leave Memory All Clear Mode.

Note:

- * Memory All Clear Mode is disabled when Recording Mode is active.
- * Make sure to keep the device powered while clearing memory or deleting Records to avoid risk of data corruption.

[#] KEY

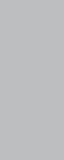

Start/End Record

- ◆ While in Standby Mode, hold down [#] for 1 second to start recording of data. A Record will be created with corresponding Start Timestamp. The device will enter Recording Mode and logging is enabled. The display will show "0" number of inputs.

- 1.) The Record will be a collection of data logs composed of input Timestamps, which will be saved on every press of input keys.

- ◆ While in Recording Mode, hold down [#] for 1 second again to end recording of data. The Record will be terminated and saved with corresponding number of inputs and End Timestamp.

- 2.) The Memory No., indicated by MEM, will increment by 1 everytime a new Record is saved.

- 3.) While saving, the display will blink twice showing the Memory No. and corresponding Timestamp, then the values saved.

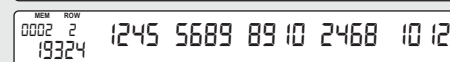

- 4.) After saving, the device will enter Standby Mode and data recording is disabled.

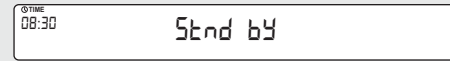

Note:

- * The Record End Timestamp will be used to identify Records in Memory Recall Mode and as Record Name when data is downloaded on the companion software.

INPUT KEYS



Recording Mode

- ◆ While in Recording Mode, press any of the input keys to enter an input Timestamp and increment the number of inputs.

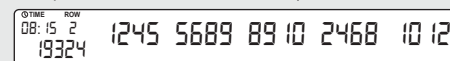

Note:

- * Make sure to push the input keys properly to avoid missed input.

[SUB] KEY

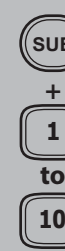

Recording Mode

- ◆ Hold down [SUB] and press any of the input keys to decrement the number of inputs.

Setting Mode

- ◆ Hold down [SUB] and press [1], [2], [3], [4] or [5] to decrement values being edited such as Year, Month, Day, Hour, Minute, or Device ID digit values.
- ◆ Holding down [SUB] and also holding down these keys will continuously decrement the values being edited.

Note:
* While [SUB] is held down, the "SUB" icon will appear on the upper right corner of the display.

ROW KEY



Recording Mode, Memory Recall Mode

- ◆ While in Recording Mode or Input Value Display in Memory Recall Mode, press [ROW] to change the row displayed between Row 1 and Row 2.
Row 1 will show Input 1 – Input 5
Row 2 will show Input 6 – Input 10.

MEMORY CAPACITY

The device memory can save up to 250 records, which is achieved when only a maximum of 111 Timestamps are saved per record.

A memory low indicator MEM LO will be blinking twice every 5 seconds when the size of memory used is 80% or more.

A memory full indicator MEM FULL will be blinking when 100% of memory is used.

※ Important!
When memory is full, starting a new Record will erase the oldest Record to free up memory space for the new Record created. Location of Records will shift and Memory No. will change accordingly.

When memory is full and device is in Recording Mode, saving a new log that requires additional memory space will erase the oldest Record to free up memory space. While erasing a Record, the device will show a "Record Data to Clear" message, and logging of input key press is temporarily disabled.

SPECIFICATIONS

Count Range	Display: 4-Digit 0 ~ 9999, Internal: 5-Digit 0~99999
Total Count Range	6-Digit 0~999999
Operating Temperature	0°C ~ 50°C (non-freezing)
Operating Humidity	35~85% RH (non-condensing)
Storage Temperature	-10°C ~ 60°C (non-freezing)
Dimension	96 (H) x 170 (W) x 25 (D) mm
Weight	Approx. 185g (accessories not included)
Compliance	CE, RoHS

For more details, please visit our website at <http://www.lineseiki.com>

ATTENTION!

Operation

- Do not use this device near machines that emit strong electromagnetic fields or objects that store static electricity.
- Do not drop or subject this device to strong impact.
- Do not use or store this device where it will be exposed to water or in places with wet conditions.
- Do not use or store this device where it can be exposed to high temperature and high humidity.
- See the battery case markings to ensure that the batteries are properly installed.
- Do not attempt to disassemble or modify this device.
- When using the device via USB power, avoid excessive movement to ensure that the device will not be disconnected and power will not be lost.
- The unit is shipped with protective seal on the display.