

# DK-5000 SERIES MANUAL

INSTRUCTION MANUAL

DK-5010A

TYPE

A

Thank you for purchasing our product, DK-5010A.  
Please confirm that you have the correct device by checking the product label.  
Please read this instruction manual carefully before using this device to ensure correct usage.  
Please keep this instruction manual for future reference.



Please note that misuse of this device may lead to injury to the user or damage to the device.  
Please observe all safety precautions and warnings in this instruction manual.

Customer Service

**LINE SEIKI CO., LTD.**

Head Office 37-7 Chuo-cho, 2-Chome Meguro-ku,  
Tokyo JAPAN 152-0001  
Contact TEL : 03-3716-5151 FAX : 03-3710-4552  
E-mail webtrade@line.co.jp  
URL http://www.lineseiki.com

## INTRODUCTION

DK-5010A is an electronic tally device with ten (10) counters. It can store the individual count values and the total count with a corresponding timestamp which is called a *Record*. This device can save up to 250 *Records* in its memory and has a built-in calendar clock for timestamp.

This device has a dedicated companion software which enables user to download, delete and save data from the device to a computer. It also enables real-time display of the device on the computer. It can be downloaded from our website free of charge.

The software runs on Windows 7, 8, 8.1 or 10 OS.

※ Important!

Please use a micro B-to-A USB cable to connect the DK-5010A device to a computer.

## POWER SUPPLY

The device can be powered through three power supply options. The list below shows the power supply options according to priority of usage:

- ▶ 5.5mm DC Jack @9V, 50mA ※
- ▶ USB Power @5V, 100mA
- ▶ 4pcs. AAA Battery

※ Please use Line Seiki AC/DC Power Adapter for DK-5000 (sold separately) to power the device via DC jack.

Upon initial connection to a power supply or resumption of power, the device will perform the start-up routine, blinking all LCD segments for 2 – 7 seconds. After this start-up routine, the device will proceed to Date & Time Setting mode to set the device *Date & Time*. (See KEY OPERATION for details.)

※ Important!

Calendar clock will not update when there is no power supply available. Make sure that there are batteries installed before disconnecting both DC jack and USB power supply to maintain calendar clock function. When DC jack or USB power is connected, power is not supplied from the batteries and battery charge will not be drained.

When operating only on batteries, fresh Alkaline type batteries can provide at least up to 200 hours of operation, under normal operating condition.

Icon will appear on the upper right corner of the display to indicate a low battery condition.  
Icon will blink continuously under following conditions:

- ▶ when battery is almost empty
- ▶ when no battery is installed while the device is powered by DC jack and/or USB

If all power supplies are removed, the last displayed value and the last device *Date & Time* will be stored in a temporary memory. When the device is powered ON again, it will resume operation in Date & Time Setting mode using the last saved *Date & Time* values. After *Date & Time* has been set, the last saved count values will resume. (See KEY OPERATION for details.)

## OPERATION MODES

This device has three main operation modes, namely:

- 1 Count Mode    2 Setting Mode    3 Memory Recall Mode

### Count Mode

This is the default operation mode. The display shows the values of individual counters and the total count. Count Mode is indicated by **TIME** icon and the current time shown on the upper left side of the display.

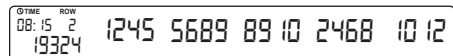

Count key presses are recognized in this mode. The individual counters and the total count are updated with every press of corresponding count key.

By pressing the corresponding key combination of [F] with [1], [2] or [3], other operation modes can be accessed from Count Mode. (See KEY OPERATION for details.)

### Setting Mode

There are two Setting Modes:

- a.) Date & Time Setting  
b.) Device ID Setting

In these respective modes, the *Date & Time* and *Device ID* can be viewed and edited. (See KEY OPERATION for details.)

### Memory Recall Mode

This mode enables viewing of all saved *Records* on the device memory. Memory Recall Mode is indicated by MEM icon and the 4-digit *Memory No.* shown on the upper left side of the display.



*Memory No.* represents the memory location of the *Record* displayed. When a *Record* is deleted, the memory location of each *Record* shifts and *Memory No.* is changed accordingly.

There are two display modes available for viewing stored *Records*:

- a.) Timestamp Display  
b.) Count Value Display

Timestamp Display mode will show the date and time when the *Record* is saved.

Count Value Display mode will show the individual count values and the total count.

Memory Recall Mode also provides an option to clear all *Records* saved in the device memory. (See KEY OPERATION for details.)

## SOFTWARE

This device works with DK-5000 Mieruzzo Software. The software is downloadable for free from the Line Seiki website.

The software enables the user with the following functions:

- download the data from the device
- export the downloaded data to a .XLS or .CSV file
- delete records stored in the device
- sync device time to computer system time
- change Device ID

The software also has an Auto Acquire function which enables real-time display of count values displayed on the device. The display is updated every 1 second.

Please refer to the DK-5000 Mieruzzo Software User's Manual for more details.

When the device is connected to the software, the icon will appear on the upper right corner of its display.

## LABELS

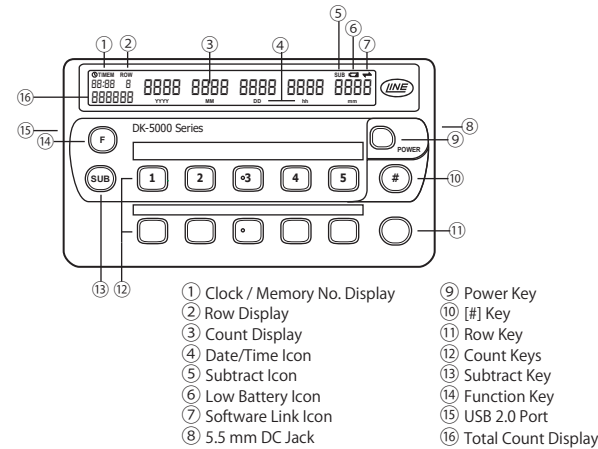

## KEY OPERATION

### POWER KEY

#### Power (On/Off)

- ◆ To switch ON, hold down [POWER] for 1 second.
  - ◆ To switch OFF, hold down [POWER] for 3 seconds.
- When switching OFF, the displayed count values will be retained and will be resumed when the device is switched ON again.

### [F] KEY

#### Date & Time Setting

- ◆ Hold down [F] and press [1] to enter the Date & Time Setting Mode. The display will show the *Date* and *Time* value in the format below: "YYYY-MM-DD-hh-mm".



The *Year*, *Month*, *Day*, *Hour* or *Minute* values can be incremented by pressing [1], [2], [3], [4] or [5]. Holding down [1], [2], [3], [4], or [5] will continuously increment these values, respectively.

- ◆ Press [F] to leave the Date & Time Setting Mode and return to Count Mode.

#### Device ID Setting

- ◆ Hold down [F] and press [2] to enter the Device ID Setting Mode. The display will show the *Device ID*, a 3-digit user-programmable number which is used to identify different DK-5000 devices.



Each digit of the *Device ID* can be incremented by pressing [3], [4] or [5]. Holding down [3], [4] or [5] will continuously increment each digit.

- ◆ Press [F] to leave the Device ID Setting Mode and return to Count Mode.

Note:

- \* Editing of *Device ID* is disabled when there is an active connection to the companion software.

### [F] KEY

#### Memory Recall

- ◆ Hold down [F] and press [3] to enter Memory Recall Mode. The display will show the *Memory No.* and *Timestamp* of the newest *Record* saved.



If there is no *Record* available, the display will show "no data".

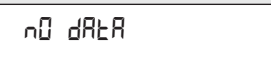

- ◆ Press [1] to display the next *Record*.
- ◆ Press [2] to display the previous *Record*.
- ◆ Press [3] to toggle Timestamp Display mode.
- ◆ Press [4] to toggle Count Value Display mode.
- ◆ Press [5] to enter Memory All Clear Mode (see details below).
- ◆ Press [F] to leave the Memory Recall Mode and return to Count Mode.

#### Memory All Clear

- ◆ When in Memory All Clear Mode, the display will show the "All Clear" options.



- ◆ Hold down [4] for 1 second to select "Yes". All *Records* will be deleted and device will return to Memory Recall Mode, "no data" will be displayed. While clearing the memory, device will show "All Data to Clear".

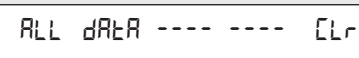

- ◆ Press [5] to select "No". No *Record* will be deleted and the device will return to Memory Recall Mode.
- ◆ Press [F] to leave Memory All Clear Mode.

Note:

- \* Make sure to keep the device powered while clearing memory or deleting *Records* to avoid risk of data corruption.

#### Record Data w/o Reset

- ◆ Hold down [F] and press [5] to save a *Record* of the current count values and corresponding *Timestamp* without resetting the count values.

- 1.) The 4-digit *Memory No.*, indicated by MEM, will increment by 1 everytime a new *Record* is saved.
- 2.) While saving, the display will blink twice showing the *Memory No.* and corresponding *Timestamp*, then the count values saved.

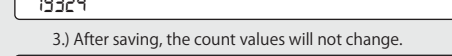
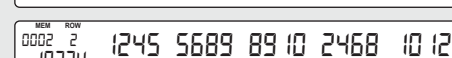

- 3.) After saving, the count values will not change.

Note:

- \* The *Record Timestamp* will be used to identify *Records* in Memory Recall Mode and as *Record Name* when data is downloaded on the companion software.

### COUNT KEYS

#### Count Mode

- ◆ While in Count Mode, press any of the count keys to increment the corresponding count value.

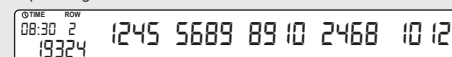

Note:

- \* Make sure to push the count keys properly to avoid miscount.

### [SUB] KEY

#### Count Mode

- ◆ Hold down [SUB] and any of the count keys to decrement the corresponding count value.

#### Setting Mode

- ◆ Hold down [SUB] and press [1], [2], [3], [4] or [5] to decrement values being edited such as *Year*, *Month*, *Day*, *Hour*, *Minute*, or *Device ID* digit values.
- ◆ Holding down [SUB] and also holding down these keys will continuously decrement the values being edited.

Note:

- \* While [SUB] is held down, the "SUB" icon will appear on the upper right corner of the display.

### [#] KEY

#### Record Data

- ◆ While in Count Mode, hold down [#] for 1 second to save a *Record* of the current count values and corresponding *Timestamp*.

### [#] KEY

#### Record Data (continuation)

- 1.) The 4-digit *Memory No.*, indicated by MEM, will increment by 1 everytime a new *Record* is saved.
- 2.) While saving, the display will blink twice showing the *Memory No.* and corresponding *Timestamp*, then the count values saved.

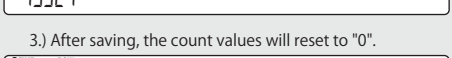
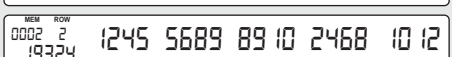

- 3.) After saving, the count values will reset to "0".

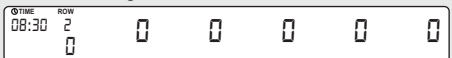

Note:

- \* The *Record Timestamp* will be used to identify *Records* in Memory Recall Mode and as *Record Name* when data is downloaded on the companion software.

### ROW KEY

#### Count Mode, Memory Recall Mode

- ◆ While in Count Mode or Count Value Display in Memory Recall Mode, press [ROW] to change the row displayed between Row 1 and Row 2.  
Row 1 will show Count 1 – Count 5.  
Row 2 will show Count 6 – Count 10.

## MEMORY CAPACITY

The device memory can save up to 250 records.

A memory low indicator **MEM** will be blinking twice every 5 seconds when the size of memory used is 80% or more.

A memory full indicator **MEM FULL** will be blinking when 100% of memory is used.

※ Important!

When memory is full, saving a new *Record* will erase the oldest *Record* to free up memory space for the new *Record* being saved. Location of *Records* will shift and *Memory No.* will change accordingly.

## SPECIFICATIONS

Count Range	Display: 4-Digit 0 ~ 9999, Internal: 5-Digit 0~99999
Total Count Range	6-Digit 0~999999
Operating Temperature	0°C ~ 50°C (non-freezing)
Operating Humidity	35~85% RH (non-condensing)
Storage Temperature	-10°C ~ 60°C (non-freezing)
Dimension	96 (H) x 170 (W) x 25 (D) mm
Weight	Approx. 185g (accessories not included)
Compliance	CE, RoHS

For more details, please visit our website at <http://www.lineseiki.com>

## ATTENTION!

### Operation

- Do not use this device near machines that emit strong electromagnetic fields or objects that store static electricity.
- Do not drop or subject this device to strong impact.
- Do not use or store this device where it will be exposed to water or in places with wet conditions.
- Do not use or store this device where it can be exposed to high temperature and high humidity.
- See the battery case markings to ensure that the batteries are properly installed.
- Do not attempt to disassemble or modify this device.
- When using the device via USB power, avoid excessive movement to ensure that the device will not be disconnected and power will not be lost.
- The unit is shipped with protective seal on the display.