

TC series Thermocouple probe



*Material of thermocouple

K type : Chromel (alloy of nickel and chromium) & Alumel (alloy of nickel)

*MAX. Temp. shown here is the temperature the thermocouple probe is guaranteed for while in ordinary use, not the breakdown temperature.

*Sheath type protection pipe has magnesium oxide isolation on the inside.

Pipe type is not isolated on the inside.

Sheath type is durable enough to be bended. However, please do not bend pipe type.

*Our thermocouples are compliant with JIS K-type, Class 2.

Accuracy: -40°C (104°F) - $+333^{\circ}\text{C}$ (631°F) : $\pm 2.5^{\circ}\text{C}$ (4.5°F)

333°C (631°F) - 1200°C (2192°F) : $\pm 0.75\%$ of reading

*The min. measuring temp. of our thermocouple probes is " $- 40^{\circ}\text{C}$ ".

URL <https://www.lineseiki.com>



LINE SEIKI CO., LTD.

37-7 Chuo-cho, 2-Chome
Meguro-ku, Tokyo 152-0001 Japan
Please visit our company website for contact details
webtrade@line.co.jp

Thermocouple probe

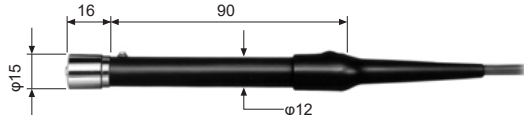
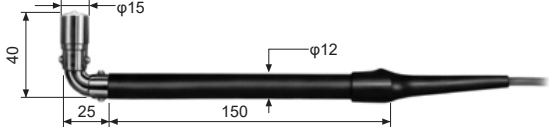
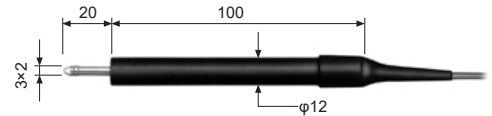
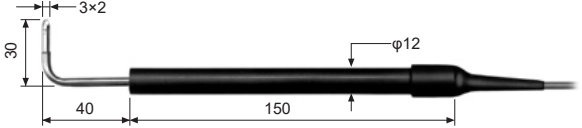
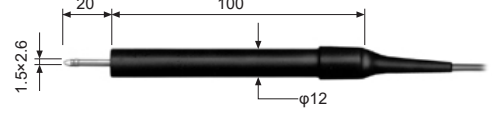
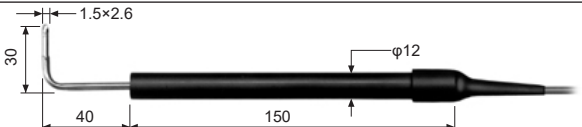
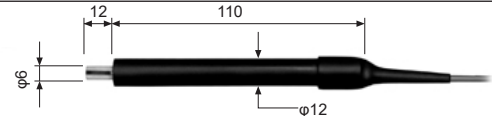
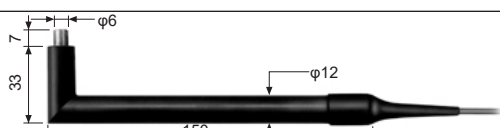
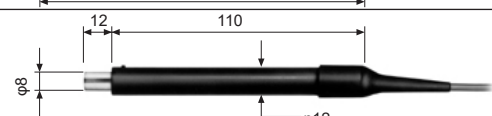
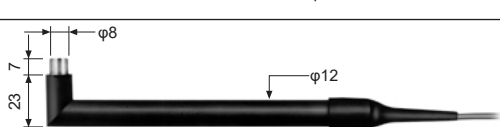
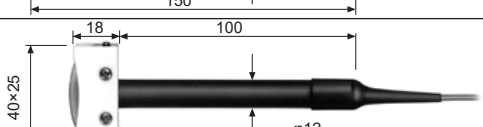
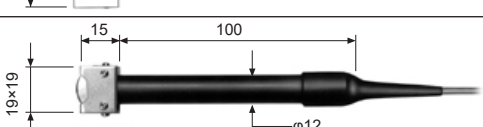
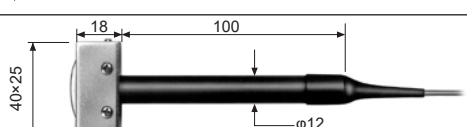
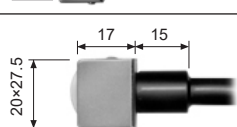
Model No.	Type	Max. Temp.	Dimensions(mm) Cable:L=1000	Applications
KF-01A	K	500°C		Surfaces
KF-02A	K	500°C		Surfaces / Hard-to-reach surfaces
KF-03A	K	500°C		Small surfaces
KF-04A	K	500°C		Small surfaces / Hard-to-reach surfaces
KF-05A	K	250°C		Small surfaces
KF-06A	K	250°C		Small surfaces / Hard-to-reach surfaces
Discontinued KF-07A	K	400°C		Small surfaces
KF-08A	K	400°C		Small surfaces / Hard-to-reach surfaces
KF-09A	K	400°C		Small surfaces
KF-10A	K	400°C		Small surfaces / Hard-to-reach surfaces
KF-12A	K	250°C		Moving rollers (with diameter of 100φto flat), Convex surfaces
KF-13A	K	400°C		Moving rollers (with diameter of 20φto flat), Convex surfaces
KF-14A	K	400°C		Moving rollers (with diameter of 100φ to flat), Convex surfaces
KF-15A	K	250°C		Surfaces (with magnet)

Model No.	Type	Max. Temp.	Dimensions(mm) Cable:L=1000	Applications	
KF-16A	K	1,000°C		Surfaces (with high temperature)	
KF-17A	K	250°C		Surfaces Low-Cost Model	
KF-18A	K	250°C		Surfaces / Hard-to-reach surfaces Low-Cost Model	
Model No.	Type	Max. Temp.	Dimensions(mm) Cable:L=1000	Applications	Type / Material of protection pipe
KB-20A	K	400°C		Liquids / Interiors of Semi-solids	Pipe type / SUS304
KS-21A	K	800°C		Liquids / Interiors of Semi-solids (with high temperature)	Sheath type / SUS316
KB-22A	K	300°C		Liquids / Interiors of Semi-solids	Pipe type / SUS304
KS-22A	K	650°C		Liquids / Interiors of Semi-solids	Sheath type / SUS316
KS-23A	K	800°C		Liquids (with high temperature)	Sheath type / SUS316
KB-24A	K	250°C		Liquids (Chemical resistance)	Pipe type / SUS304 with fluorocarbon polymers tube
KS-60A	K	400°C		Liquids / Small spot surfaces	Sheath type / SUS316
KB-66A	K	300°C		Liquids / Interiors of Semi-solids	Pipe type / SUS304
KB-75A	K	300°C		Gases	Pipe type / SUS304

Thermocouple probe

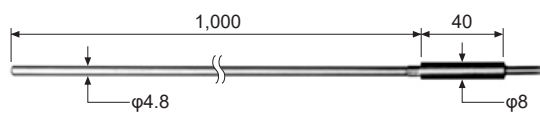
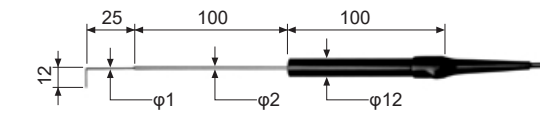
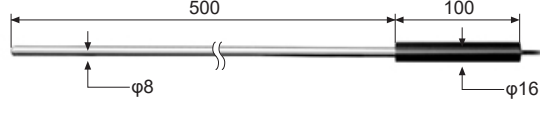
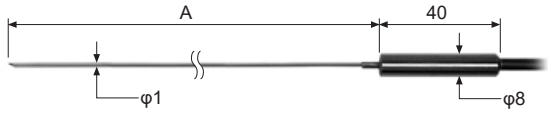
Model No.	Type	Max. Temp.	Dimensions(mm) Cable:L=1000	Applications	Type / Material of protection pipe
KS-80A	K	900°C		Liquids (Heavy-duty purposes)	Sheath type / SUS316
KB-81A	K	400°C		Liquids / Gases	Pipe type / SUS304
KS-82A	K	1,050°C		Liquids (with high temperature)	Sheath type / Inconel®
KS-96A	K	650°C		Liquids / Interiors of Semisolids (Hard-to-reach measuring objects)	Sheath type / SUS316
KS-97A		450°C			

Wire type Thermocouple probe and Extension cable

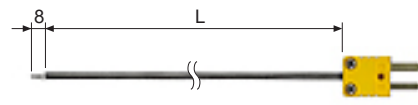
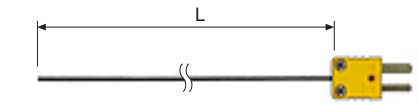
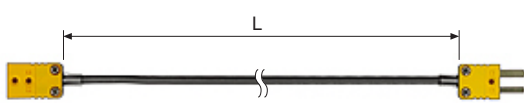
Model No.	Type	Dimensions(mm) Cable:L=1000	Applications	Type / Material of protection pipe
Wire type KW-6-□□□□TM	K		Liquids / Gases	Wire type with fluorocarbon polymers coating
Wire type KW-6-□□□□GM	K		Liquids / Interiors of Semi-solids	Wire type with Fiberglass coating
Extension cable KC-6-□□□□PM	K		—	PVC

ORDERING INFORMATION FOR WIRE TYPE THERMOCOUPLE PROBE & EXTENSION CABLE

<p>Thermocouple type K type : K</p> <p>Selection of type Wire type : W Extension cable : C</p> <p>Sheath Dia. φ0.32 : 2 φ0.65 : 6</p> <p>Length L = □□□□ cm (1cm - 1,000cm)</p>	<p>Termination Miniature connector : M</p> <p>Insulation PVC : P(90°C) fluorocarbon polymers : T(200°C) Fiberglass : G(250°C)</p>
---	---

Miniature connector

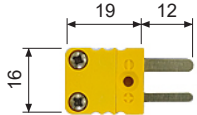
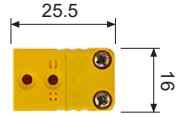
Model No.	Type	Dimensions	Type
KM-62A	K		Plug
KM-63A	K		Jack

*SUS304 & SUS316 are stainless steel.

*Inconel is nickel based alloys. INCONEL is a registered trademark of Special Metals Corporation.

*Probes for moving rollers are without wheels.

This catalog was last revised Sep. 21, 2021.

*Subject to change without prior notice.

All Rights Reserved, Copyright © 2021, LINE SEIKI CO., LTD.