

MZ SERIES

MINIATURE NON-RESET ELECTRIC COUNTER

- Non-Reset, Super mini size
- Low Cost, Low power consumption
- Suitable for limited space installations in office equipments, amusement equipments, etc.
- Applications : Slot Machine, Copy Machine, Fax Machine, Vending Machine, Other Industrial Machine

MODEL SELECTION

| TYPE | MODELS | DIGITS | MOUNTING | CONNECTION | |
|----------------------------|----------|--------|----------------------------|------------|------------------------------------|
| NON-RESET TOTAL COUNTER | MZ - 600 | 6 | Rear | LEADWIRE | |
| | MZ - 700 | 7 | | | |
| | MZ - 620 | 6 | Base | | |
| | MZ - 720 | 7 | | | |
| | MZ - 630 | 6 | Behind Panel (Screw Mount) | | |
| | MZ - 730 | 7 | | | |
| | MZ - 640 | 6 | Base | | |
| | MZ - 740 | 7 | | | |
| | MZ - 670 | 6 | Panel (Snap-in-type) | | |
| | MZ - 770 | 7 | | | |
| | MZ - 602 | 6 | PCB | | TERMINAL PIN (Pitch : 12.7 mm) |
| | MZ - 702 | 7 | | | |
| | MZ - 612 | 6 | PCB | | TERMINAL PIN (Pitch : 10 mm) |
| | MZ - 712 | 7 | | | |

SPECIFICATIONS

| | |
|-----------------------|--|
| Display | 6 digits : 3.0 x 2.0mm / 7 digits : 3.0 x 1.6 (white on black background) |
| Power Source | DC 12V, 24V |
| Voltage Fluctuation | -15 - +10% |
| Power Consumption | 1.2 W |
| Continuous Energizing | Permissible |
| Counting Method | One pulse - One count (energizing - ½ count, unenergized - ½ count) |
| Counting Speed | 10Hz, 20Hz |
| Pulse Width | 50msec. minimum |
| Make (Duty) | 1 : 1 |
| Count Life | 6 digits : 3,000,000 counts minimum / 7 digits : 10,000,000 counts minimum |
| Reset | None |
| Connection | Leadwire 265mm / PCB Type: Pin |
| Operating Temperature | -5°C - +40°C (non-freezing) |
| Operating Humidity | 85%RH maximum (non-condensing) |
| Test Voltage | AC1,500V for 1 minute |
| Insulation Resistance | 50MΩ minimum (500VDC megger) |
| Vibration | Endurance : 16.7 Hz, Width : 4mm ; XYZ each direction for 1 hour Malfunction : 10 - 55 Hz, Width : 0.5mm ; XYZ each direction for 10 mins. |
| Shock | Endurance : 294 m/s ² (30G) XYZ 5 times each direction, Total : 30 times Malfunction : 49 m/s ² (5G) XYZ 4 times each direction, Total : 24 times |
| Construction | Cover : Plastic (Black) |
| Weight | 30 grams |

DIMENSIONS

MZ - 600 • 700

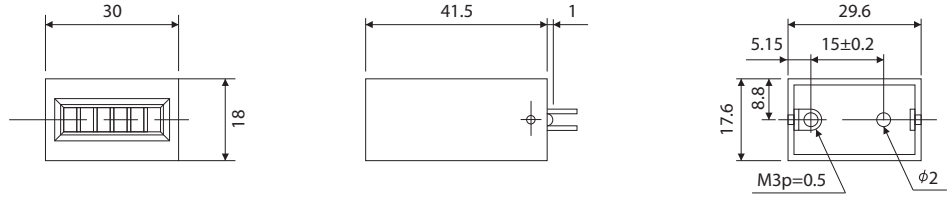

MZ - 620 • 720

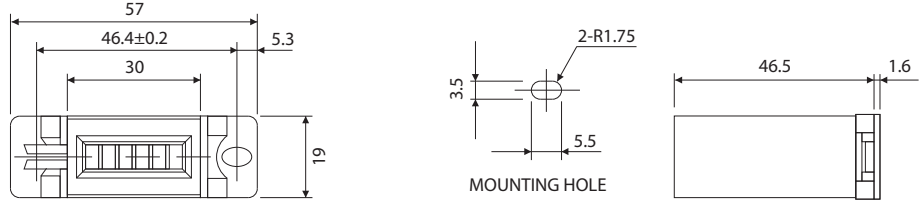

MZ - 630 • 730

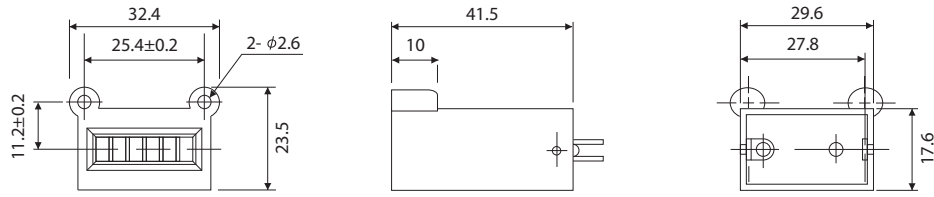

MZ - 640 • 740

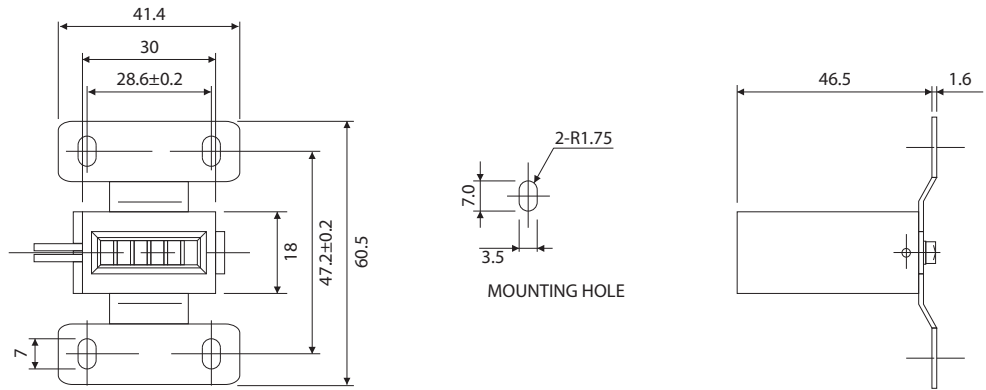
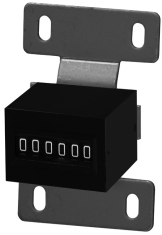

MZ - 670 • 770

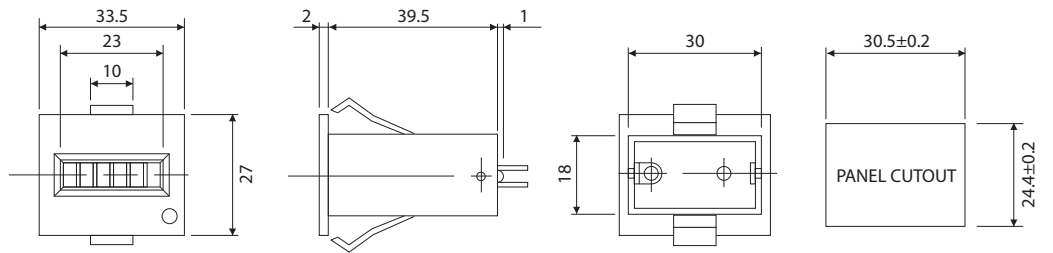

MZ - 602 • 702

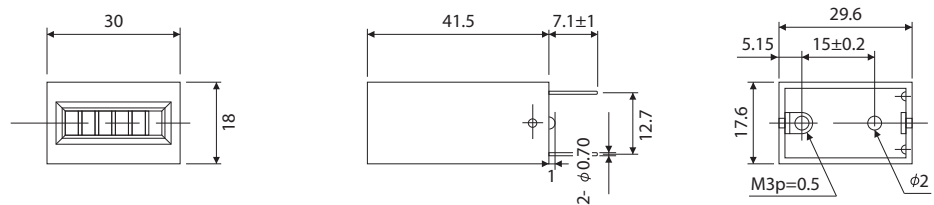

DIMENSIONS

MZ - 612 • 712

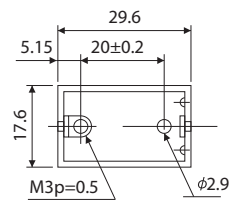
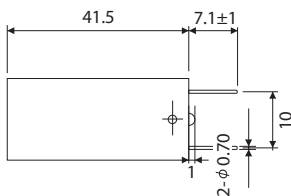
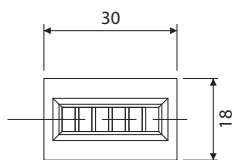

This catalog was last revised Jul. 11, 2018
*Subject to change without prior notice.
All Rights Reserved, Copyright © 2018, LINE SEIKI CO., LTD.



LINE SEIKI CO., LTD.

Address : 37-7, Chuo-Cho, 2-Chome, Meguro-ku
Tokyo 152-0001 JAPAN
Contacts : Tel: +81-3-3716-5151 Fax: +81-3-3710-4552
E-mail: webtrade@line.co.jp
URL : <http://www.lineseiki.com>