

GC2/GH2/GM2/GS2 SERIES

- Lithium battery installed inside. Battery life 7 years(replaceable)
- Front Panel Protection IP54
- In Conformance to CE(EMC)
- RoHS compliant
- In Conformance to UL



- 6/8digits LCD display with 10.6mm height
- Panel Cut-out 50.0 x 25.0mm



MODELS

● G□2 SERIES(GC2/GH2/GM2/GS2)

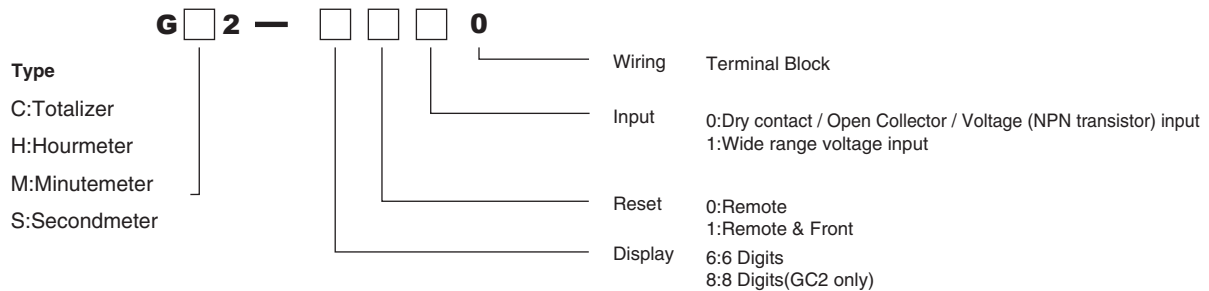

SPECIFICATIONS

Type	GC2 Totalizer	GH2 Hourmeter	GM2 Minutemeter	GS2 Secondmeter
Display	6/8 digits, 7-segment LCD 10.6mm(H)	6 Digits, 7-Segment LCD 10.6mm(H)		
No. of digit	0 - 999999/0 - 99999999		0.0 - 99999.9	
Spec of input	Max.count speed G□2-□□ 00 30Hz G□2-□□ 10 20Hz	Resolution 1count per 1/10 hour	Resolution 1count per 1/10 minute	Resolution 1count per 1/10 second

MECHANICAL / ENVIRONMENTAL SPECIFICATIONS

Ambient Temp. : Operating	-10 - +55°C(Non-freezing)
Ambient Temp. : Storage	-20 - +65°C(Non-freezing)
Ambient Humid. : Operating	25 - 85%RH(Non-condensing)
Vibration / Shock Resistance	Operation : Single amplitude 0.35mm Frequency 10-55Hz X.Y.Z. Axis 100mm/s ² Storage : Single amplitude 0.75mm Frequency 10-55Hz X.Y.Z. Axis 300mm/s ²
Protection of front panel	IP54
Weight	60g (Battery included)
Wiring	Terminal type:14-22 AWG lead wires to be connected by screws.

ELECTRICAL SPECIFICATIONS

Input	Dry Contact / Open Collector / Voltage (NPN transistor)	L:<0.8V H:2 - 30V	Sink current 8 μ A
	Wide range voltage	L:DC/AC 0 - 5V H:DC/AC 20 - 250VInput	impedance:300k Ω
Reset	Front Reset Remote Reset	L:<0.8V H:2 - 30V	Sink current 8 μ A
	Dry Contact / Open Collector / Voltage (NPN transistor)	L:DC/AC 0 - 5V H:DC/AC 20 - 250VInput	impedance:300k Ω
Reset pulse width	6ms MIN.		
Power source	3.6V 1/2AA Lithium Battery (replaceable), 7 years min. with continuous input at 25°C *The battery life is not a guaranteed value.		
Noise Immunity	Electrostatic Discharge	IEC-61000-4-2	8kV
	Radiated Electromagnetic Field	IEC-61000-4-3	10V/m
	EFT/B.I/O Leads	IEC-61000-4-4	1.0kV
EMC standard	EMI : EN50081-2 EMS: EN50082-2		

DIMENSIONS

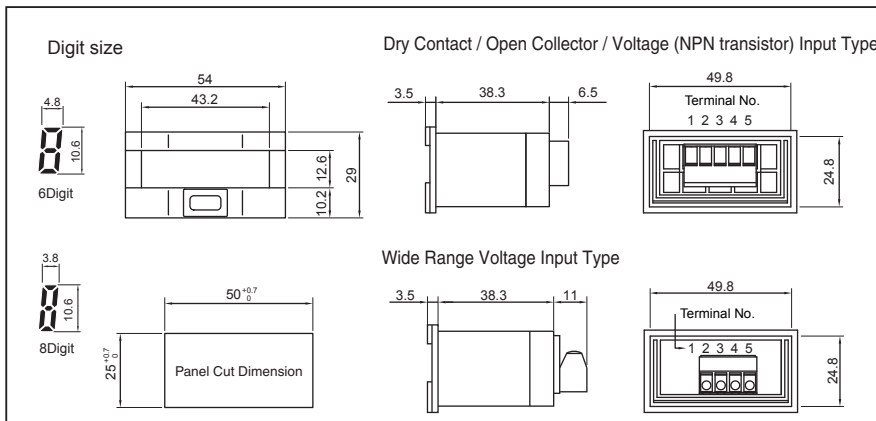

MOUNTING

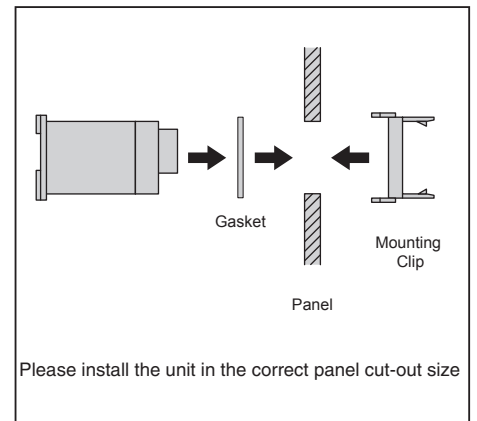

WIRING

<G□2-□□00>

Dry Contact / Open Collector / Voltage (NPN transistor) Input Type

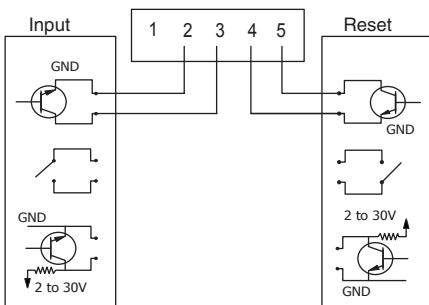

<G□2-□□10>

Wide Range Voltage Input Type

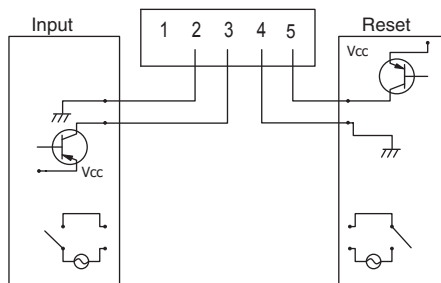

● Input Theory

<G□2-□□00>

Dry Contact / Open Collector / Voltage (NPN transistor) Input Type

Input terminal No.3 : Count at Hi → Lo

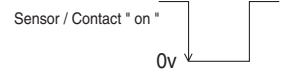

<G□2-□□10>

Wide Range Voltage Input

Input terminal No.3 : Count at Lo → Hi

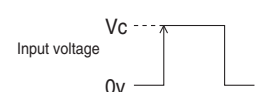

This catalog was last revised June. 24, 2015.

*Subject to change without prior notice.

All Rights Reserved, Copyright © 2015, LINE SEIKI CO., LTD.



LINE SEIKI CO., LTD.

Address : 37-7, Chuo-Cho, 2-Chome, Meguro-ku
Tokyo 152-0001 JAPAN

Contacts : Tel: +81-3-3716-5151 Fax: +81-3-3710-4552

E-mail: webtrade@line.co.jp

URL : http://www.line-seiki.com